

(1) Introduction & accessories

Thank you for purchasing the new AOR AR2700 wide band receiver.

This operating manual is divided into many sections and presented in a logical order assuming that it will be read section by section following the examples. However, **if you are familiar with the operations of modern multi-function receivers you may proceed directly to section 6.** Many phrases are repeated through the manual, while this may make the text a little repetitious, it should provide clear instructions if you refer directly to a specific section.

Every effort has been made to make this manual correct and up to date. Due to continuous development of the receiver and by error or omissions, anomalies may be found and this is acknowledged.

Most apparent faults are usually due to accidental misoperation of the receiver, carefully read all of the manual before deciding to return the receiver for repair.

Although carefully designed, this receiver (like all receivers) suffers from a degree of internal noises known as spuri. They are a product of the receiver's circuitry and do not represent a fault.

This manual is protected by copyright AOR LTD 1995. No information contained in this manual may be copied or transferred by any means without the prior written consent of AOR LTD. AOR and the [AOR] logo are trade marks of AOR, LTD. All other trade marks and names acknowledged. E&OE.

© 1995 AOR LTD.

Operating manual Conventions and special notes

Where text appears in **[SQUARE BRACKETS]** the keys are to be pressed exactly as shown.

For example: **[1] [4] [5] [ENT]**

Means press the **1** key followed by the **4** key followed by the **5** key followed by the **ENTER** key.

The arrow keys to the lower left of the keypad are referred to as **UP / DOWN** or **[UP] [DOWN]** keys.

Words contained in speech marks "BANK" refer to indications displayed on the Liquid Crystal Display.

Where memory banks etc are empty the indication "- -" is often displayed.

[2ndF] function key: The function key **[2ndF]** provides access to additional facilities via the numeric keypad. The function key should be momentarily pressed only (so that the legend "2ndF" appears in the top left corner of the LCD) before another numeric key is pressed... **do not hold the function key in while pressing other keys.**

AR2700 operating manual

[PWR] power switch: The power switch is not of the traditional “click” operation but microprocessor controlled, this is to facilitate the sleep timer. **To switch the receiver On, press and hold the [PWR] key for more than 1.5 seconds.** Similarly to switch the receiver Off, press and hold the **[PWR]** key for more than 1.5 seconds.

Full microprocessor reset: Later in this manual reference is made to FULL microprocessor reset. The AR2700 takes about 30 seconds to recover following a FULL reset as all memory and search data has to be deleted... be patient as 30 seconds feels like a very long time when you are waiting. Remember also, when there is no memory or search data, the AR2700 will not scan or search until you have input new data.

1-1 Accessories supplied

- 4 x AA internal high capacity rechargeable NiCad batteries
- Mains charger
- DC power lead with cigar lighter plug
- Telescopic whip aerial
- Belt clip with two screws
- Hand strap
- Operating manual

(2) Table of contents

1		Introduction and accessories	1
	1-1	Accessories supplied	2
2		Table of contents	2
3		Major features	4
4		Precautions	6
	4-1	Location	6
	4-2	Looking after your receiver	6
	4-3	Power requirements	6
	4-4	NiCads and charging	7
	4-5	Aerial (antenna) connection	8
5		Controls and functions	9
		TOP PANEL	9
	5-1	Aerial (antenna) input	10
	5-2	Earphone connection / speaker connection	10
	5-3	[DIAL] - tuning control / selector	10
	5-4	Squelch control	10
	5-5	Volume control	11
		FRONT PANEL	11
	5-6	Liquid Crystal Display LCD	11
	5-7	Keypad (extensive information)	11
	5-8	Internal loudspeaker	22
		LEFT HAND SIDE	22
	5-9	[2ndF] function key	22
	5-10	[MONI] monitor key	23
	5-11	[K.LOCK] keypad lock key	23

AR2700 operating manual

5-12	[RESET] microprocessor reset switch	23
	RIGHT HAND SIDE	24
5-13	DC 12V - charging and DC input socket	24
	REAR CABINET	24
5-14	RS232 REMOTE connector	25
5-15	Battery compartment	25
6	Basic manual operation of the receiver	26
6-1	Before starting	26
6-2	Switching On	26
6-3	Entering frequencies (using the keypad)	27
6-4	Correcting frequency input	28
6-5	Changing frequency - UP / DOWN keys & [DIAL] ...	29
6-6	Changing frequency step (PROGRAM)	29
6-7	Changing receive mode (PROGRAM)	31
6-8	Attenuator	32
7	Memory banks & channels	33
7-1	Storing receive data into memory	33
7-2	Automatic memory incrementation	34
7-3	Memory recall	35
7-4	Transfer of memory channels to VFO	36
7-5	Memory over-write	36
7-6	Deleting memory channels and banks	37
8	Priority operation	38
8-1	Entering data into the priority channel	38
8-2	Activating & deactivating priority	39
8-3	Programming priority sampling interval	39
9	SCAN - scanning memory channels & banks	40
9-1	Starting to scan, considerations	40
9-2	Scanning a memory bank	40
9-3	Memory transfer to VFO	41
9-4	Scanning a single memory bank to scan	42
9-5	Memory bank linking	42
9-6	Scanning a memory bank which is not linked	43
9-7	Scan channel PASS	43
9-8	Memory scan channel pass while scanning	43
9-9	Memory channel pass - review	43
10	Delay and Pause facilities - scan & search	44
10-1	Delay time	44
10-2	Pause time	45
11	SEARCH	46
11-1	Manual search	46
11-2	Frequency pass in search mode	48
11-3	Program search banks	49
11-4	Reviewing program search parameters	50
11-5	Programming and reprogramming search banks ...	51
11-6	Program search bank linking	53
11-7	Searching a search bank which is not linked	54
12	Sleep timer - automatic power off	54
12-1	Enabling sleep time	55
12-2	Defining the sleep time period	55
13	Optional VOICE recording facility	55
13-1	Initialising the voice record option	55
13-2	Recording	56

AR2700 operating manual

13-3	Record - Play back	56
14	Remote control using a computer (RS232)	56
14-1	Setting RS232 parameters	57
15	Clone (copy) data between two AR2700	57
15-1	Transferring data by clone	57
16	Trouble shooting	58
16-1	Microprocessor reset	58
16-2	Other possible operating problems	59
16-3	Other LCD indications & error messages	60
16-4	Special functions	61
17	Optional accessories	62
18	Specification	63

(3) Major features

General

The AR2700 is a new generation of receiver combining a wide frequency coverage with advanced features and facilities.

Internal construction is of a high quality modular surface mount design. This ensures the highest levels of performance and reliability.

Frequency coverage and modes

The AR2700 boasts a wide frequency coverage of 500kHz to 1300MHz without gaps in the range (actual acceptable frequency input from 100kHz). Step size is programmable: **AM/NFM** 5kHz, 6.25kHz, 9kHz, 10kHz, 12.5kHz, 20kHz, 25kHz, 30kHz, 50kHz, 100kHz and **WFM**: 50kHz & 100kHz. Modes of reception are: AM, NFM and WFM and may be selected on any frequency within the receiver's range.

Auto-Mode tuning

Comprehensive band plan information specific to the target market area has been programmed into the AR2700 receiver. This inclusion will greatly simplify frequency entry and search programming, the receiver will "automatically" select the appropriate mode and channel step. Of course, should you wish then both the mode and channel step may be manually changed when required.

Wide variety of search & scan facilities

Great flexibility is offered by the microprocessor. Search & scan may be selected using various parameters such as PROGRAM SEARCH, MANUAL SEARCH, BANK LINK, DELAY, PAUSE, PASS etc. plus PRIORITY.

AR2700 operating manual

Memories and search banks

A total of 500 memory channels are provided which are divided into 10 banks, each having 50 channels. The AR2700 will search and scan at a very respectable (and fast) maximum speed of approximately 30 increments per second.

In addition there are 10 programmable search banks, all of which may be programmed by the operator for different start / end frequencies, mode and channel step.

The data contents of memory and search banks are held in an EEPROM so that no backup battery or capacitor is required for memory retention.

Copy (CLONE) between two AR2700 receivers

The stored memory and search data may be transferred from one set to another using an optional adaptor and interface (IF-ADP & CU8232).

Full computer control

The computer control port may be connected via an optional adaptor and interface (IF-ADP & CU8232) to a computer for remote control of the receiver (control software will be required).

On screen battery indication

The AR27000 permanently displays the battery level status when switched On, this is achieved by a special indication on the LCD.

Sleep timer

The AR27000 has an auto power off sleep timer programmable between 1 and 120 minutes. A special indication on the LCD shows when the facility has been activated.

Optional VOICE recording

An optional VOICE recoding chip (RU2700) may be internally fitted to permit 20 second digital recording and play back of transmissions.

Other facilities

The AR2700 is truly full featured, among other facilities are keypad beep On/Off, plus keypad lock and microprocessor reset.

(4) Precautions

4-1 Location

Do not use or leave the receiver in direct sunlight (especially the LCD). It is best to avoid locations where excessive heat, humidity, dust and vibration are expected. Always treat the receiver with care.

Take care to avoid spillage or leakage of liquids into the receiver and AC charger. Special care should be taken to avoid liquid entering via the power jack and earphone sockets. Always remove batteries if the receiver is not going to be used for a while.

Avoid static discharge from discons or long wire aerials, earth to a central heating radiator or similar earthing point in order to discharge the wire aerial before connection to the receiver. Always **disconnect and earth** any external aerial system if an electrical storm is expected.

Avoid connecting / disconnecting the power connection or batteries with the set switched On. Avoid a rapid switch On/Off sequence. If switched Off, leave at least two seconds before switching On again. Ensure the mains plug connections are tight and other DC connections (such as cigar lighter plugs) secure.

Avoid strong RF fields from nearby transmitters. If in doubt, disconnect the AR2700 from the aerial and switch the set Off.

4-2 Looking after your receiver

Always keep the receiver free from dust and water. Use a soft dry cloth to gently wipe the set clean. Never use chemicals such as benzine or thinners which will damage certain parts.

4-3 Power requirements

The AR2700 is designed for operation from internal NiCad batteries, internal dry batteries or an external DC supply of 11 - 16V DC at approximately 300mA minimum.

Always use the mains charger provided or a regulated DC power supply of 13.8V @ 300mA or more using the provided DC connecting lead. **NEVER CONNECT THE AR2700 DIRECTLY TO THE MAINS SUPPLY.** Always switch the receiver Off when connecting or disconnecting the receiver.

Note: The DC input socket uses a standard dual concentric 1.3mm connector. The connector is **CENTRE POSITIVE** (which is the RED terminal of most DC power supplies). The outer connector is **NEGATIVE** - ground.

Should you be using the AR2700 at home with an external aerial, a separate earth connection may be made between the outer earth connector of the BNC

AR2700 operating manual

plug and water pipe, central heating system radiator or external earth rod. If fitting a separate external earth rod, consider the implications carefully if your mains supply uses a Protective Multiple Earth (PME) system. If in doubt consult an experienced electrician. Never earth to a gas pipe!

Always disconnect the charger from the AC mains supply when not in use.

If using dry batteries (Alkaline or Manganese), always remove the batteries when exhausted or if the AR2700 is not going to be used for a while. This will avoid leakage which could seriously damage the receiver.

There is a special on screen battery indicator with three segments indicating state of charge / drain. The indicator is useful in providing a short period of warning of low battery power.

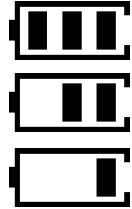

Three segments indicates that there is plenty of charge in the batteries, two segments indicate that the batteries are beginning to lose their charge and one segment indicates that the batteries are about to expire.

Background noise may still be heard from the loudspeaker even though the batteries are exhausted, usually the Liquid Crystal Display or receiver fails to operate in this condition.

Access to the battery compartment is via a removable sub-panel on the rear of the unit using a downward motion. Always switch the receiver Off when inserting or removing batteries. If fitting new batteries always select a quality brand, 4 x AA size 1.2 or 1.5V cells are required.

When replacing batteries the receiver may automatically switch On, this is quite normal.

4-4 NiCads and charging

Before operating, charge the internal NiCad batteries using the supplied charger for approximately 16 hours.

NiCads are prone to “**memory effect**”, as a result they may have to be cycled (fully charged then used until flat) 3 or 4 times before they provide a truly full period of operation. Once charged, you should never again leave the NiCads in a flat condition. Although you may charge the NiCads in order to “top up” their capacity if you have only used the set for an hour or two, the NiCads should be cycled at least once per month to ensure continued long term reliability.

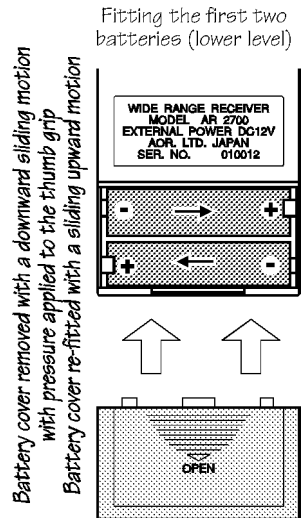

AR2700 operating manual

Important!

Do not overcharge the NiCad pack, 16 hours is sufficient from flat. In severe cases of overcharging high temperatures may be generated, this can result in damage to the NiCads and to the receiver. If this point is ignored, there is a small but potential danger of personal injury due to explosion. Never short circuit NiCad batteries, the effect is similar to overcharging but happens very quickly. Never attempt to charge dry batteries.

Fitting the second two batteries (upper level)

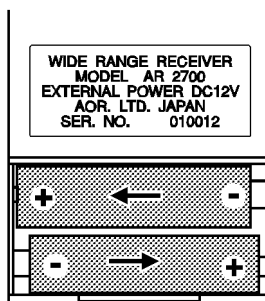

4-5 Aerial (antenna) connection summary

The aerial input is via a high quality BNC 50 OHM socket. The standard supplied telescopic whip should provide good result across most of the receiver's frequency coverage with the exception of short wave & medium/long wave.

The BNC socket should also permit straight forward connection to almost any type of receive aerial setup.

It is not possible to further increase sensitivity on medium wave, firstly due to the up-conversion receive circuit employed (which is required for high quality VHF-UHF reception) and secondly due to the potential noise from the microprocessor (being a compact hand-held design).

Aerial attenuator

An aerial attenuator system allows selection of 0dB or 10dB. This is especially useful in reducing the potential for breakthrough when using external aerial systems.

Do remember, if considering the use of an external aerial, there will be a greater chance of signal overload and breakthrough. While this will not damage the receiver in average use, it may degrade the receive performance due to the effects of "signal mixing". Liberal use of the attenuator may be required.

VHF - UHF discone aerials

Ideally, separate aerials should be employed for each frequency or band of interest. Of course, except for government listening stations this is totally impractical. For this reason most people choose an externally mounted discone aerial such as the AOR DA3000 aerial. The DA3000 has a usable frequency coverage of 25 to 2000 MHz.

AR2700 operating manual

Shortwave long wire aerials

For the shortwave bands a different type of aerial will be required. The most common form is the random long wire connected to the centre terminal of the BNC plug or wrapped around the retracted telescopic whip aerial.

Aerial Tuning Units (ATU)

An ATU can improve the selectivity of any shortwave receiver when connected to long wire aerials. This valuable extra selectivity is achieved by the ATU rejecting out of band signals enabling the receiver to "single out" one band of frequencies while rejecting potentially strong unwanted transmissions.

Active desktop loop aerials

Usually designed for the shortwave bands (such as the AOR LA320). Loop aerials have the advantage of small size when compared to long wire aerials and being within easy reach of the operator they may be rotated to provide directivity. The circuitry offers a small level of gain with the advantage of selectivity similar to an ATU.

(5) Controls and functions

The AR2700 receiver is housed in an attractive and modern looking grey plastic cabinet. Controls for operation are located on the top, front and left hand side of the cabinet.

Top Panel

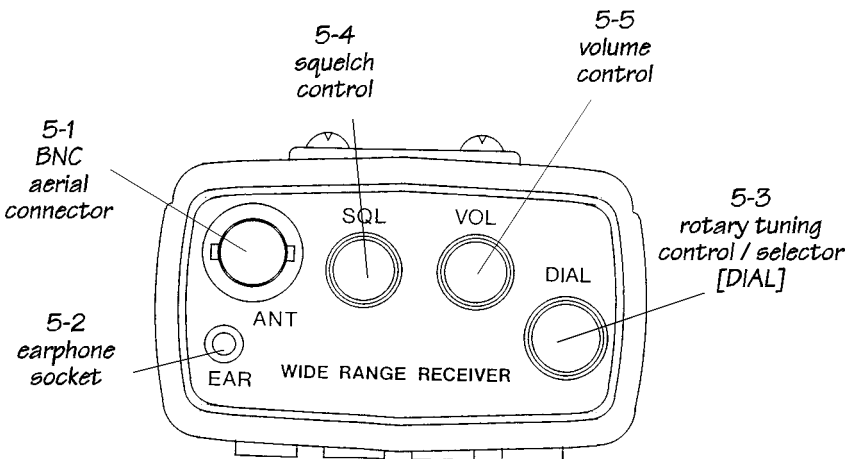

AR2700 top panel

AR2700 operating manual

5-1 Aerial (antenna) input

The aerial input is via a high quality BNC 50 OHM socket. The standard supplied telescopic whip should be connected to this point and provide good result across most of the receiver's frequency coverage.

5-2 EAR - Earphone / speaker connection

This 3.5mm mono socket permits connection to an external earphone, headset or speaker of 8 OHM impedance or greater. When this earphone socket is used, the internal speaker will be automatically disconnected.

5-3 DIAL - tuning control / selector

The DIAL control is prominently located on the top of the cabinet for ease of use. This control changes the received frequency up and down in whatever step increment is selected and operates as a "selector" when entering certain data through menus. This type of rotary control is often referred to as the "VFO".



Being a mechanical device, it is not uncommon for operations to be occasionally missed and this does not constitute a fault (unless excessive).

5-4 SQ - squelch control

The squelch control is used to eliminate unwanted background noise when monitoring a normally inactive frequency and is used by the AR2700 microprocessor to determine when a channel is "active" (busy). The receiver cannot scan or search when the background noise is present.



The squelch control requires careful setting to achieve optimum operating performance. Rotate the control clockwise until the background noise just disappears (threshold), this is the most sensitive setting of the control. In practice the control is usually rotated a little further clockwise beyond the threshold point to prevent the receiver from stopping on noise or very weak and unreadable signals.

If the control is rotated too far clockwise then weaker signals will be totally lost and only local strong signals will be heard.

When the squelch control is rotated anti-clockwise so that background noise is audible, the squelch is referred to as being "OPEN". In a similar manner, when the squelch control is rotated clockwise so that the background noise is muted, the squelch is referred to as being "CLOSED".

The squelch is not usually used when listening to short wave transmissions due to the relatively high short wave background noise levels nor in WFM mode. The usual setting for the control when listening to short wave or WFM is fully anti-clockwise (squelch open).

AR2700 operating manual

Note: **Even when the squelch is fully CLOSED a low level background noise may still be audible.** This is because the receiver's audio amplifier circuit is permanently operational in order to provide fast search/scan rates and an efficient squelch opening characteristic. This phenomenon is common with other hand-held receivers on the market today.

5-5 VOL - volume control

The volume control is located on the top face of the cabinet. This control is used to set the required audio output from the receiver. When rotated fully clockwise the volume is at maximum, when rotated fully anti-clockwise the volume is reduced to minimum.

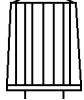

Front panel

5-6 Liquid Crystal Display (LCD)

The AR2700 uses a high contrast Liquid Crystal Display. Due to its mechanical construction the LCD is best viewed from directly in front of the receiver, a fairly wide viewing angle is still maintained.

The LCD is custom manufactured and has legends for mode, channel step, bank number, frequency etc.

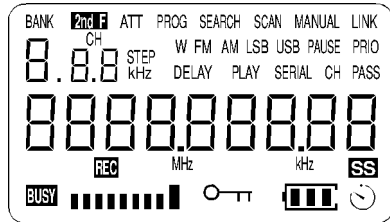

A full test pattern may be displayed by holding the [1] key while switching the receiver On until the set fully powers up. Not all legends are used by the AR2700. To remove the test pattern, briefly press the [PWR] key again.

Attractive green rear illumination of the LCD (and keypad) is switchable for use in locations of low level lighting.

The LCD will provide frequency readout to tens of Hertz (the last digit on the right is used when using 6.25 kHz steps otherwise it will always read "0").

The lower left corner of the LCD displays a legend "BUSY" to indicate that the squelch is open. To the right is the signal strength presented as a bar graph. The stronger the signal then the larger the graph, if there is no signal present this area of LCD will be blank. **It is quite common for a few of the signal meter segments to appear due to background band noise even when no signal is present.**

5-7 Keypad

The front keypad comprises of twenty press keys laid in a grid four horizontal and five vertical. The keys are multi-function and are used to input frequency

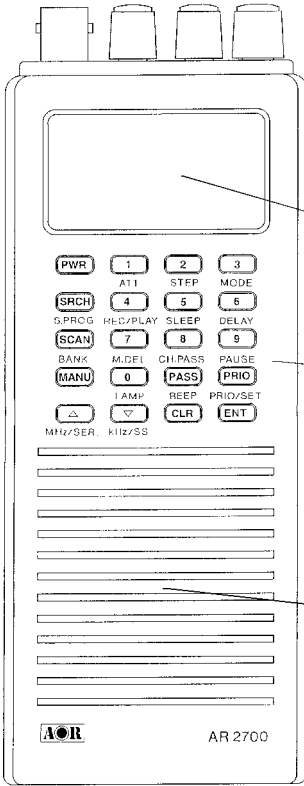

AR2700 front panel

5-6
liquid
crystal
display
L.C.D.

5-7
keypad

5-8
internal
speaker

and other operational data in conjunction with the left side panel [2ndF] function key and top panel [DIAL].

If a key is not pressed within about 30 seconds during data entry, the entry will be aborted and the receiver will return to the previous display.

Attractive green rear illumination of the front keypad and LCD is switchable for use in locations of low level lighting.

The basic operational description of each key is as follows:

[PWR] - power On/Off key

When the [PWR] key is pressed and held for more than 1.5 seconds the microprocessor will switch the receiver On. The requirement of PRESS AND HOLD prevents accidental switch On and Off.

PWR

AR2700 operating manual

When correctly activated and BEEP enabled, a high pitch bleep will confirm operation.

To switch the receiver Off simply press and hold the key again for more than 1.5 seconds. If the BEEP is enabled and you press the key for too short a period, a low pitch beep advises of the error.

The **[PWR]** switch is not of a common volume control combined arrangement as a SLEEP timer can also switch the receiver Off when programmed and activated. Resetting the microprocessor from the external reset switch will also cause the receiver to power On.

The K.LOCK (key lock) switch located on the left side panel prevents accidental switch On and Off of the receiver. This is an extremely useful feature when carrying the set in a coat pocket or bag.

Note: It is quite normal for a click to be heard as the receiver is powered On and often the lamp will momentarily illuminate. A low level hiss may also be heard from the speaker when in quiet surroundings, this is because the audio amplifier is permanently powered in order to provide fast scan & search rates and to facilitate a good squelch characteristic. The set may switch On when changing batteries or when connecting external power to the receiver, this is normal and you should be aware of and check for this condition.

[SRCH] [S.PROG] - search & search program key



When the **[SRCH]** key is first pressed the receiver initiates a the search process for one of the programmed search banks. The bank currently being searched is indicated by the legends "BANK 1" for example in the top left hand corner of the LCD and the word "SEARCH" in the centre of the top row of the LCD.

If no data is stored in the program search banks, the set will not be able to search.

When **[SRCH]** is pressed a second time **during search**, the SEARCH process is cancelled and the current search frequency is transferred to the VFO returning the receiver to MANUAL mode where the frequency may be monitored or used as the starting point for tuning. As the search process is terminated you may also decide to write the frequency into a memory channel or resume searching again. To return from SEARCH to MANUAL mode and receive the original frequency without transferring the search frequency press **[MANU]**.

The key sequence **[2ndF] [SRCH]** (short press of the [SRCH] key) initiates the process for programming the search banks to your own specification of frequency range, step size, attenuator and mode... this is referred to as PROGRAM SEARCH input.

The key sequence **[2ndF] [SRCH]** (long press of the [SRCH] key for more than 1.5 seconds) initiates the process for linking search banks together.

AR2700 operating manual

[SCAN] [BANK] - scan / memory recall / search bank preview key

SCAN

BANK

When the **[SCAN]** key is pressed briefly, the receiver enters MEMORY RECALL mode, the display legend "BANK" appears on the top left of LCD along with bank and channel number. The receiver monitors whatever frequency is displayed on the LCD. The numeric keypad may be used to recall a specific memory channel between 000 - 049, 100 - 149, 200 - 249 etc up to 949. Alternatively the **UP / DOWN** keys may be used to sequence through MEMORY CHANNELS WHICH CONTAIN DATA ONLY, the **[DIAL]** may also be rotated with the same effect.

When **[SCAN]** is pressed a second time (this means pressing while "BANK" is displayed), the receiver returns to MANUAL mode and the memory data is transferred to VFO where it may be monitored or used as the starting point to tune from. To return to MANUAL mode without transferring the memory contents press **[MANU]** instead.

When **[SCAN]** is pressed a second time (this means pressing while "BANK" is displayed) **and held for more than 1.5 seconds**, the receiver enters scan mode and starts looking for active frequencies in the currently selected memory bank(s). Alternatively the **[UP]** or **[DOWN]** keys may be pressed and held for more than 1.5 seconds at this point to initiate the scan process.

If a busy channel is located, the scan process will wait until the channel clears before continuing. You may force the scan process to continue or reverse in direction by using the **UP / DOWN** keys or **[DIAL]**.

The sequence **[2ndF] [SCAN]** (in other words the selection of **[BANK]**) has three different effects depending upon the operational mode of the receiver at the time the sequence is keyed.

Manual mode

If the sequence **[2ndF] [BANK]** is keyed in manual mode, the legend "BANK" is displayed on the top left corner of the LCD along with a bank number. The bank number represents the current MEMORY BANK where you wish data to be stored during memory write, the receiver automatically increments to the first available empty location in the bank selected. Use the **UP/ DOWN** keys or **[DIAL]** to select the memory bank starting point for memory write, to accept the selection press **[ENT]**.

This sequence is not essential as the bank may always be specified during memory write, however this facility may increase the speed of data entry at critical times when there is plenty of interesting activity to save in the memory banks.

Search mode

If the sequence **[2ndF] [BANK]** is keyed in search mode, the legend "BANK" is displayed on the top left corner of the LCD along with a bank number. The upper and lower limits of program search are displayed along with the legends

AR2700 operating manual

“HI” and “Lo”. Use the **UP / DOWN** keys or **[DIAL]** to select the desired program search bank, pressing **[ENT]** or **[CLR]** will cause the receiver to search the selected program search bank.

Scan mode

If the sequence **[2ndF] [BANK]** is keyed in scan mode, the legends “BANK” and “CH” are displayed in the top left corner of the LCD. The receiver will pause on the currently displayed channel for about 30 seconds before resuming the scan process again. The **UP / DOWN** keys, **[ENT]** key or **[DIAL]** may be used to force the scan process to resume.

The sequence **[2ndF] [SCAN] with the [SCAN] key held for more than 1.5 seconds**, causes the receiver to enter the SCAN BANK LINK menu regardless of whether the receiver is in SEARCH, SCAN or MANUAL operational modes.

[MANU] - manual mode

MANU

The AR2700 receiver has a manual operational mode often referred to as VFO MODE. The term VFO historically means “Variable Frequency Oscillator” and today refers to a tunable data store which contains frequency, mode, channel step, and attenuator information.

Pressing the **[MANU]** key places the receiver into a known operational condition ready for data entry. The display legend “MANUAL” appears toward the top right of the LCD. If you are ever unsure what operational mode the receiver is in, press the **[MANU]** key.

Manual mode is used for frequency entry, change of mode, general listening and memory write (data entry - into memory channels and program search banks).

The key sequence **[2ndF] [MANU] (with the [MANU] key held for more than 1.5 seconds)** places the receiver into MANUAL SEARCH MODE with the legend “SEARCH MANUAL” appearing on the top line of the LCD. The receiver will search upward or downward from the currently displayed frequency in whatever mode and channel step selected. The **UP / DOWN** keys or **[DIAL]** may be used to reverse the direction of manual search.

The receiver will stop on active channels and the **UP / DOWN** keys or **[DIAL]** may be used to force the process to continue passed the busy frequency. To cancel manual search and monitor the currently displayed frequency press the **[MANU]** key. (Holding the **UP** or **DOWN** keys for more than 1.5 seconds also places the receiver into manual search mode.

[UP] / MHz / SER - key

CH.PASS

The **[UP]** key is used as a DECIMAL $\rightarrow \bullet \leftarrow$ during the entry of frequencies during frequency input through the numeric keypad.

AR2700 operating manual

For example 133.7 MHz [1] [3] [3] [MHz] [7] [ENT] there is no need to add trailing zeros. Frequencies below 1 MHz may be preceded by [0] [MHz] frequency then [ENT].

The [UP] key may be used to force the receiver to continue search / scan from a busy channel and to reverse the direction of search / scan should the receiver be tracking downward. The key will also act as an upward tuning control just like DIAL.

The key is also used to select menu options under certain circumstances.

The key may be used to place the receiver in manual search mode by pressing and holding the [UP] key for more than 1.5 seconds while in manual mode.

The key sequence [2ndF] [UP] places the receiver in ready condition to CLONE data to another AR2700 connected to an optional CU8232 via the optional IF-ADP. This facility enables an exact data copy of one receiver to be made with another possibly belonging to a friend etc. The display "COPY SEnd" and a flashing legend "SERIAL" indicates operation.

Use the UP / DOWN keys or [DIAL] to toggle between SEND and RECEIVE modes, press [ENT] to accept the selection, always select the receive unit first. The first segment of the signal bar graph will appear to confirm operation, as the data transfer progresses so the bar graph will grow to indicate that the process is functioning correctly. It will take a few minutes to transfer all the data.

The sequence [2ndF] [UP] with the UP key being held for more than 1.5 seconds places the receiver into the menu to select the RS232 parameters for connection to a computer via the optional IF-ADP and CU8232 adaptor and interface units.

The [DIAL] is used to select the baud rate between 9600, 4800 and 2400 bps and the UP / DOWN keys select the addition of LF (line feed).

[DOWN] / kHz / SS - key



The [DOWN] key is used as a kHz key during frequency entry and provides an alternative method of frequency entry to the MHz (decimal) key method.

For example, a frequency of 945 kHz may be entered as [0] [MHz] [9] [4] [5] [ENT] or [9] [4] [5] [kHz] [ENT] the later taking one less key press.

This kHz method of entry makes entry from short wave frequency listings particularly easy. A listing of 6045 kHz (6.045 MHz) may be entered as [6] [0] [4] [5] [kHz] [ENT]

The [DOWN] key may be used to force the receiver to continue search / scan from a busy channel and to reverse the direction of search / scan should the receiver be tracking upward. The key will also act as a downward tuning control just like DIAL.

The key is also used to select menu options under certain circumstances.

The key may be used to place the receiver in manual search mode by pressing and holding the **[DOWN]** key for more than 1.5 seconds while in manual mode.

The sequence **[2ndF] [DOWN]** places the receiver into "SS" descramble mode, refer to the information supplied with the optional printed circuit board, not available within the UK.

The sequence **[2ndF] [DOWN] with the DOWN key being held for more than 1.5 seconds** places the receiver into "SS" descramble select mode, refer to the information supplied with the optional printed circuit board, not available within the UK.

[1] [ATT] Numeric 1 / ATTENUATOR key



This key acts as a numeric 1 when entering frequencies via the keypad.

In search, scan and memory modes this key is used to identify bank 1.

If the sequence **[2ndF] [1]** is keyed, the attenuator is toggled On/Off. The ATTENUATOR is a useful feature to aid with the reduction of interference caused by the presence of strong signals.

[2] [STEP] Numeric 2 / STEP key



This key acts as a numeric 2 when entering frequencies via the keypad.

In search, scan and memory modes this key is used to identify bank 2.

If the sequence **[2ndF] [2]** is keyed, the tuning STEP size may be selected.

[3] [MODE] Numeric 3 / MODE key



This key acts as a numeric 3 when entering frequencies via the keypad.

In search, scan and memory modes this key is used to identify bank 3.

If the sequence **[2ndF] [3]** is keyed, the receive MODE may be selected.

[4] [REC/PLAY] Numeric 4 / Record / Play (optional) key



This key acts as a numeric 4 when entering frequencies via the keypad.

In search, scan and memory modes this key is used to identify bank 4.

AR2700 operating manual

If the sequence **[2ndF] [4]** is keyed, the legend "PLAY" will be displayed on the LCD and a previous 20 second digital recording may be replayed (presuming that the optional record chip has been fitted). If the optional chip has not been fitted then white noise will be heard.

The signal meter acts as a "progress meter" to illustrate how much record and play back time has elapsed.

If the sequence **[2ndF] [4]** is keyed with the **[4]** key held for more than **1.5 seconds**, the legend "REC" will be displayed on the LCD and the current displayed frequency will be recorded for 20 seconds (presuming that the optional record chip has been fitted).

[5] [SLEEP] Numeric 5 / Sleep key



This key acts as a numeric 5 when entering frequencies via the keypad.

In search, scan and memory modes this key is used to identify bank 5.

If the sequence **[2ndF] [5]** is keyed, the sleep timer is enabled. A clock legend will be displayed on the lower right of the LCD and the receiver will automatically switch Off after the programmed sleep time has elapsed. To de-activate the sleep timer, key the sequence **[2ndF] [5]** a second time, the clock legend will be removed from the LCD.

To program the sleep timer between 1 and 120 minutes in one minute increments key the sequence **[2ndF] [5]** with the **[5]** key held for more than **1.5 seconds**. The new value may be keyed through the numeric keypad or the **UP / DOWN** keys may be used or the **[DIAL]**. To accept the new value press **[ENT]**.

[6] [DELAY] Numeric 6 / DELAY key



This key acts as a numeric 6 when entering frequencies via the keypad.

In search, scan and memory modes this key is used to identify bank 6.

If the sequence **[2ndF] [6]** is keyed, the global DELAY (used in search and scan modes) may be programmed by the operator. The delay is the time between the frequency becoming clear (squelch closing) and the automatic continuation of the search or scan process. The default is 2.0 seconds and the accepted range is between 0.0 and 9.9 seconds.

The value may be changed by keying in a two digit number via the numeric keypad (the decimal is automatically entered by the microprocessor) or the **UP / DOWN** keys or **[DIAL]** may be used to change the value in 0.1 second increments. Press **[ENT]** to accept the new value.

[7] [M.DEL] Numeric 7 / Memory delete key



This key acts as a numeric 7 when entering frequencies via the keypad.

In search, scan and memory modes this key is used to identify bank 7.

If the sequence **[2ndF] [7]** is keyed while in memory recall mode or when stopped on a channel during scan, the displayed frequency will be deleted from the memory bank and the set will move on to the next memory channel containing data (upward or downward depending upon how programmed).

Memory channels are usually deleted one at a time. It is possible however to delete a selected bank or all banks, this will be further described later in the manual.

[8] [CH.PASS] Numeric 8 / channel pass key

8

This key acts as a numeric 8 when entering frequencies via the keypad.

CH.PASS

In search, scan and memory modes this key is used to identify bank 8.

If the sequence **[2ndF] [8]** is keyed during memory recall mode, the legend "CH PASS" will appear on the LCD to indicate that the channel has been LOCKED OUT (passed) so that it will not be automatically scanned but will be skipped over.

This is useful for temporarily passing busy channels such as amateur band repeaters or broadcast transmissions. The locked out channel may still be recalled and monitored in memory recall mode.

To reinstate the locked out channel repeat the key sequence **[2ndF] [8]** while the desired channel is being displayed. The legend "CH PASS" will be removed from the LCD.

[9] [PAUSE] Numeric 9 / Pause key

9

This key acts as a numeric 9 when entering frequencies via the keypad.

PAUSE

In search, scan and memory modes this key is used to identify bank 9.

If the sequence **[2ndF] [9]** is keyed the global PAUSE facility will be engaged and the legend "PAUSE" will be displayed on the LCD. The pause facility is used in search and scan modes and causes the receiver to wait for a programmable period before resuming the search or scan process even if the transmission continues (when the squelch is still open). This can be very useful should unwanted continually active frequencies be encountered or if analysing activity.

To program the PAUSE time, key the sequence **[2ndF] [9] and hold the [9] key for more than 1.5 seconds**. The pause default is **05 seconds** and the accepted range is between 01 and 99 seconds. The value may be changed by keying in a two digit number via the numeric keypad, or the **UP / DOWN** keys or **[DIAL]** may be used to change the value in one second increments. Press **[ENT]** to accept the new value.

AR2700 operating manual

[0] [LAMP] Numeric 0 / Lamp key

0

This key acts as a numeric 0 when entering frequencies via the keypad. LAMP

In search, scan and memory modes this key is used to identify bank 0.

If the sequence **[2ndF] [0]** is keyed, the LAMP will be switched on for a period of about five seconds. If you are using the keypad, the five second timer starts from the last key press so that you are not inconvenienced in areas of low level lighting by the lamp switching Off while you are keying in data.

It is possible to switch the lamp On permanently using the key sequence **[2ndF] [0] with the [0] key help for more than 1.5 seconds**. This is useful for base station or mobile operation but uses more power so will reduce the operational time if running from batteries. To switch the lamp Off (if it has been switched permanently On) use the sequence **[2ndF] [0]**.

[PASS] [BEEP] Frequency pass / beep key

PASS

BEEP

The **[PASS]** key is used during search to skip unwanted frequencies, these may be permanently active control channel transmissions, broadcast stations, spuri etc. Up to 50 frequencies may be passed in this way and are held in a list numbered from 00 to 49.

When the search process stops on an active channel press **[PASS]**. The frequency will automatically be assigned to a pass channel and the set will move on to the next frequency in search mode. If the set fails to respond to the **[PASS]** key then all 50 PASS channels have probably been used up and you will need to delete some in order to make more channels available.

To review the pass list **press and hold the [PASS] key for more than 1.5 seconds while in MANUAL or SEARCH mode**. The legends "CH" and "PASS" will be flashing on the LCD to indicate that the pass list has been accessed and the first frequency in the list will be displayed along with its pass channel number "00".

The list may be reviewed using the **UP / DOWN** keys or by using the **[DIAL]**. A pass frequency may be deleted by first displaying the selected frequency in the pass list then keying **[0] [ENT]**. The frequency will disappear and the list will "shuffle down" to fill the gap which has been made. It is also possible to delete the entire list in one go, this will be described later in the manual.

Frequencies may be manually added to the pass list by first displaying the chosen pass channel then **keying in a frequency followed by [ENT]**, the pass list will increment to the next channel. To escape from the pass list press **[CLR]**.

The key sequence **[2ndF] [PASS]** toggles On and Off the keypad "beep" and "boop" confirmation tones. The beep tones can speed up entry of data via the keypad as you need to look at the LCD less often. If you have the keylock On and attempt to access the keypad, the beep low tone "boop" draws attention to the fact that the keypad is locked.

AR2700 operating manual

Should you prefer, it is possible to switch “musical notes” to most of the keypad keys when the keylock is On. This may be accomplished by **holding down the [4] key while switching On the receiver by the [PWR] key.**

The musical notes are arranged as follows:

[1]	FA	F3
[2]	SO	G3
[3]	LA	A3
[4]	TI	B3
[5]	DO	C4
[6]	RE	D4
[7]	MI	E4
[8]	FA	F4
[9]	SO	G4
[0]	LA	A4
[PASS]	TI	B4
[PRIO]	DO	C5
[DOWN]	RE	D5
[CLR]	MI	E5
[ENT]	FA	F5



While this may be fun, remember that although very hard wearing, there is always a degree of aging with mechanical devices such as keypads. It is not too difficult to make up tunes as a party piece... try Twinkle Twinkle Little Star !!!

[9] [9] [DOWN] [DOWN] [CLR] [CLR] [DOWN]
[PRIO] [PRIO] [PASS] [PASS] [0] [0] [9]
[DOWN] [DOWN] [PRIO] [PRIO] [PASS] [PASS] [0]
[DOWN] [DOWN] [PRIO] [PRIO] [PASS] [PASS] [0]
[9] [9] [DOWN] [DOWN] [CLR] [CLR] [DOWN]
[PRIO] [PRIO] [PASS] [PASS] [0] [0] [9]

[PRIO] [PRIO/SET] Priority key

The **[PRIO]** key is used to select the priority frequency, select the sampling interval and toggle the priority watch On and Off.



To toggle the priority watch On and Off press **[PRIO]**, a “PRIO” legend appears on the LCD to confirm operation and the priority frequency will be periodically checked for activity.

The priority frequency is selected in manual mode using the key sequence **[2ndF] [PRIO]**, this is referred to as PRIORITY SET.

The priority sampling interval is programmed with the key sequence **[2ndF] [PRIO] with the [PRIO] key held for more than 1.5 seconds.** The range is 01 to 19 seconds with the default being 05 seconds. The value may be changed in one second increments by using the **UP / DOWN** keys or **[DIAL]** or by keying in a two digit number via the numeric keypad. The new value is accepted by pressing **[ENT]**.

[CLR] - Clear entry key

CLR

This key will cause data entry to be cancelled should a mistake be accidentally typed and forces an escape "back to search, scan or manual mode" whichever had been previously selected. The [CLR] key is also used to escape from the frequency pass menu.

There is no second function for this key.

Should you experience a programming / operational problem with the AR2700, you may "soft" reset the microprocessor by holding the [CLR] key while powering up the receiver. Your memory bank and search bank data will remain intact but any linked bank settings etc will be lost. This has the same effect as the external soft reset switch on the left hand cabinet... use only as a last resort.

A FULL MICROPROCESSOR reset is accomplished by holding **both the [CLR] and [ENT] keys while switching On the unit using the [PWR] key.** All memory channels, search banks, pass channels etc will be lost and blank. As a result the search and scan facilities will not operate until new data has been entered. **Note: It is quite normal for the set to take about 30 seconds to recover from a FULL reset as all data is being deleted !!!**

[ENT] - Enter key

ENT

The enter key is used to finalise the entry of frequency and other data inputs.

While in manual mode, press and hold the [ENT] key for more than 1.5 seconds to add the currently displayed frequency into memory.

While in SEARCH mode and stopped on a busy channel, press the [ENT] key to write the current displayed frequency into memory.

The [ENT] key is also used during a FULL microprocessor reset.

5-8 Loudspeaker (internal)

The AR2700 is fitted with an internal front facing loudspeaker toward the lower front cabinet. When an external earphone, headphone or speaker is connected, the internal speaker is automatically disconnected.

Side panel - left hand side

5-9 [2ndF] Function key

The AR2700 uses a multi-function keyboard. The second function [2ndF] (shift) key is used to access the second key functions as listed underneath the keypad keys. Other functions may also be accessed using the function key.



2.nd.F

AR2700 left hand side

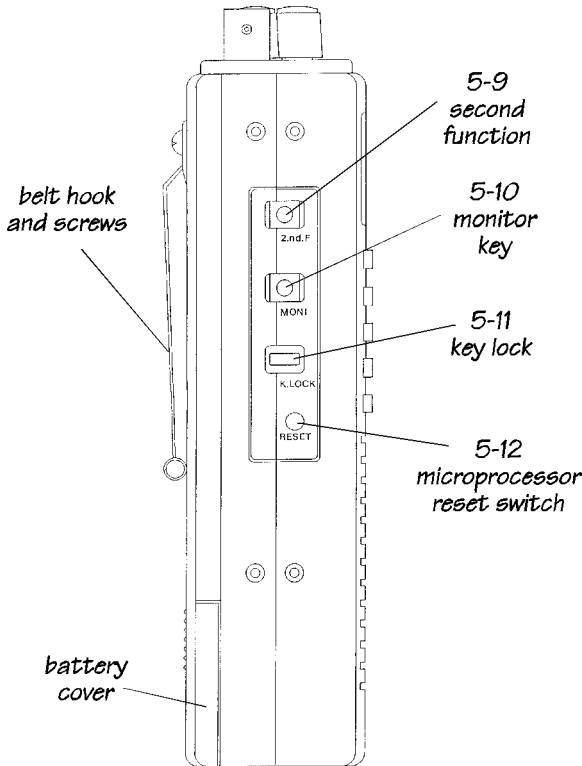

When the function key is operated, a legend "2ndF" appears in the upper left of the LCD.

The function key should be momentarily pressed only (so that the legend "2ndF" appears in the top left corner of the LCD) before another numeric key is pressed... **do not hold the function key in while pressing other keys.**

5-10 [MONI] monitor (squelch defeat) key

This key is used to defeat the squelch (open it) to allow the monitoring of very weak or fluttering signals.



5-11 [K.LOCK] keypad lock key

The [K.LOCK] slide switch has two positions and is designed to prevent accidental operation of the keypad when carrying the receiver in a pocket or bag.



When the switch is in the down position the keylock is Off. When the switch is slid upward position the keylock is On and the keypad and [DIAL] is disabled (except for the [MONI] key). A special "KEY" graphical legend on the LCD indicates when keylock is On.

5-12 RESET switch

Should you experience a programming / operational problem with the AR2700, you may "soft" reset the microprocessor by momentarily pressing the reset switch located on the left hand cabinet using a pointed



AR2700 operating manual

utensil such as a pin, small screwdriver, sharp pencil etc. It does not matter whether the receiver is switched On or Off at the time. This has the same effect as switching the receiver On by the [PWR] key while holding the [CLR] key.

Your memory bank and search bank data will remain intact but any linked bank settings, etc will be lost. This has the same effect as the external soft reset switch on the left hand cabinet... use only as a last resort.

Side panel - right hand side

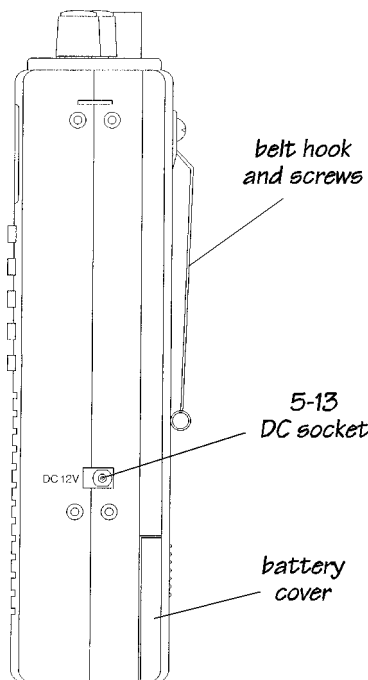

5-13 DC 12V Charging / external power connection

This is a standard 1.3mm dual concentric DC socket. The wiring of this socket is **CENTRE POSITIVE**, negative ground. **THE AR2700 MUST NEVER BE CONNECTED DIRECTLY TO THE MAINS SUPPLY.**

The DC socket is used to charge the internal NiCad batteries using the charger provided. The receiver may also be connected to an external 12V DC supply for powering away from home (such as to a vehicle 12V cigar lighter socket using the DC lead).

The AR2700 may also be connected to a separate **regulated** DC power supply for use at home. The rating of the regulated power supply must be a nominal 12V to 13.8V DC @ 300mA or higher current rating.

Rear cabinet

The battery compartment cover (which is located to the lower section of the rear case) may be removed using a downward sliding motion. Underneath the battery compartment cover are two user accessible parts, the RS232 REMOTE connector and the BATTERIES.

AR2700 operating manual

5-14 RS232C REMOTE connector

This is a very small connector located in the battery housing, the batteries need to be removed to permit access. For this reason the use of the REMOTE CONNECTOR demands the use of an external regulated power supply.

The connector is partially hidden from view by the lower battery near the serial plate and by the angle of the cabinet. An optional adaptor (IF-ADP) and interface (CU8232) is available for cloning (copying) of data between two AR2700 receivers and an RS232 lead plus software is required for computer control.

Computer control port
(Cut away may be felt with
a finger or viewed from
the bottom)

* IF-ADP & CU8232 required
for computer control

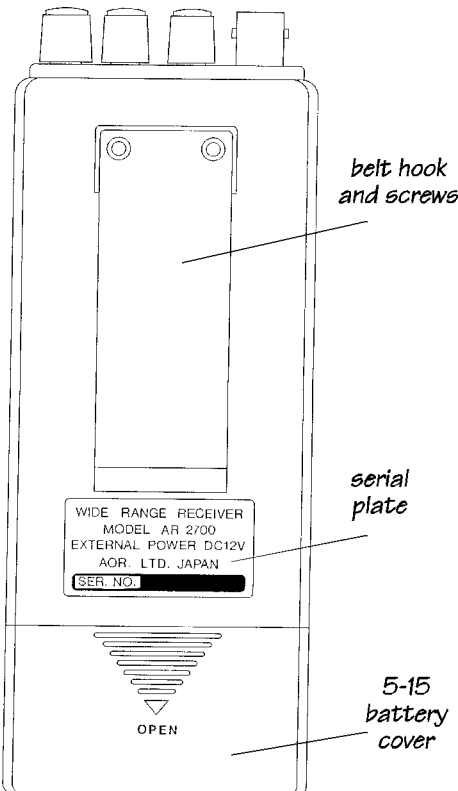
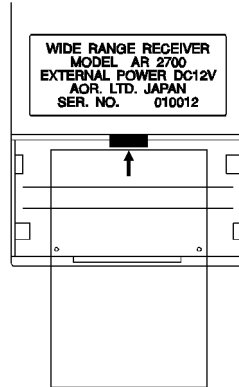

5-15 BATTERY compartment

Inside the battery compartment is a cradle designed to accept 4 x UM-3 (AA size) batteries. Carefully note the polarity of the cells (which way around they fit). Either the supplied rechargeable NiCad batteries or high quality dry batteries may be used. However, never attempt to charge the receiver or connect to an external power source when dry batteries are fitted.

Always remove dry batteries when they have expired (run down). Should you plan not to use the receiver for a period of time and have dry batteries fitted, remove the batteries to avoid leakage.

Note: The memory channel data is held by an internal EEPROM which does not require batteries or connection

to external supply. However, always switch the receiver Off when changing batteries or connecting / disconnecting external power. The receiver may switch On by itself when fitting batteries, this is quite normal.

(6) Basic manual operation of the receiver

Operating manual conventions

Where text appears in **[SQUARE BRACKETS]** the keys are to be pressed exactly as shown.

For example: **[1] [4] [5] [ENT]**

Means press the **1** key followed by the **4** key followed by the **5** key followed by the **ENTER** key.

Words contained in speech marks "BANK" refer to indications displayed on the Liquid Crystal Display.

6-1 Before starting

Before operating, charge the internal NiCad batteries using the supplied charger for approximately 16 hours. Connect the supplied telescopic whip aerial to the BNC connector.

Note: When the receiver is switched OFF, all VFO data will be automatically stored into EEPROM memory storage. No battery or capacitor is required for memory backup.

6-2 Switching On

Set the squelch control to the 12 o'clock position and rotate the volume control to the 12 o'clock position. **Press and hold the [PWR] key for more than 1.5 seconds**, this will switch the receiver On. It is never a good idea to switch On the receiver with an earphone connected, there may be an audible click when the unit is switched On or the volume may be accidentally set uncomfortably high.

In normal use, the squelch control should be rotated clockwise until the background noise is just cancelled. This is known as "threshold" and is the most sensitive setting for the squelch control. Do not rotate the control too far clockwise or only the stronger local signals will be heard. If you find setting the squelch control difficult, try removing the aerial from the receiver.

Should you encounter problems in setting the volume level, press the **[MONI]** key on the left hand panel to momentarily defeat (open) the squelch so that a comfortable volume level may be set.

AR2700 operating manual

It is best to press the **[MANU]** key at this time to place the receiver in a known state of operation... MANUAL MODE.

Note: If the keypad or **[DIAL]** is not operated for approximately 30 seconds while inputting data through a selection input option, the operation will **time out** and the receiver will return to its previous task just as if the **[CLR]** key had been pressed.

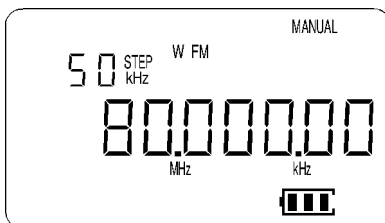

6-3 Entering a frequency through the keypad - VFO (MANUAL) MODE

When the **[MANU]** key is pressed, the receiver enters manual mode ready for input of a frequency or other data. The receiver may also be tuned using the **[DIAL]** just like a VFO. The term VFO historically means "Variable Frequency Oscillator" and today refers to a tunable data store which contains frequency, mode, step and attenuator information.

Press the **[MANU]** key to first select "MANUAL" - VFO mode (should the receiver be scanning or searching etc).

Example of frequency entry 145.800 MHz

Press **[1] [4] [5] [MHz] [8] [ENT]**

There is no need to key in the trailing zeros to the right of the decimal point as they are automatically added by the microprocessor.

If keying in a whole MHz such as 118.000 MHz there is no need to key in either the decimal point or trailing zeros, they are all added automatically by the AR2700 microprocessor.

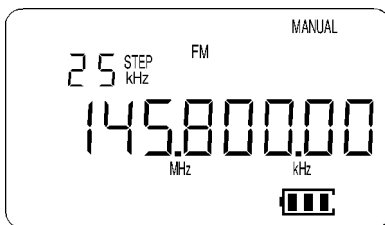

Example of "MHz round number" frequency entry for 118.000 MHz

Press **[1] [1] [8] [ENT]**

If for some reason you do not wish to complete the frequency data input, press **[CLR]** before completing the input sequence with **[ENT]**.

If an attempt is made to enter an out of range or invalid frequency (such as 1929 MHz or 0.09 MHz) the set will not receive and invalid frequencies may appear on the LCD, you may also see error messages such as "PLL Err" (PLL error) or similar.

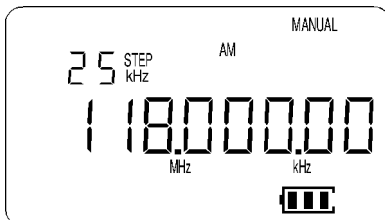

AR2700 operating manual

Remember, the frequency coverage is 500 kHz to 1300 MHz with frequencies accepted by the microprocessor from 0.1 MHz (100 kHz).

Note: If the keypad or **[DIAL]** is not operated for approximately 30 seconds while inputting data, the operation will **time out** and the receiver will return to its previous task just as if the **[CLR]** key had been pressed.

Frequencies may also be entered as kHz which is convenient when inputting data from a short wave frequency listing.

Example of frequency entry 945 kHz (0.945 MHz)

Press **[0] [MHz] [9] [4] [5] [ENT]** MHz input

Press **[9] [4] [5] [kHz] [ENT]** kHz input

The frequency of 945 kHz is equivalent to 0.945 MHz and data may be entered in either format.

You will note that frequencies below 1.6 MHz (1600 kHz) will not have a decimal point displayed to the right of the "MHz" position, this is to ensure easy recognition of frequencies which are often listed as "kHz" in frequency guides. Instead, the decimal point is positioned to the right of the kHz position

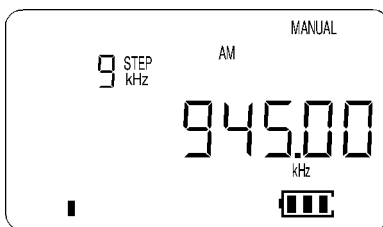

Another example of frequency entry 1215 kHz (1.215 MHz)

Press **[1] [2] [1] [5] [kHz] [ENT]**

The frequency of 1215 kHz is equivalent to 1.215 MHz.

PROG: If the frequency display changes when the **[ENT]** key is pressed, then an inappropriate step size has been selected. The AR2700 has an automatic bandplan lookup table so that an appropriate step size and mode should be selected. It is possible to override this PROGRAM data by simply selecting a different step size or mode. As a rule of thumb, the displayed frequency must be exactly divisible by the step size.

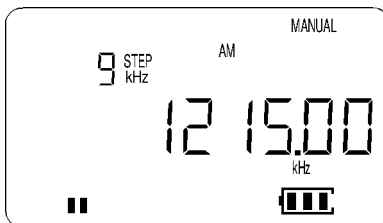

6-4 Correcting frequency input

Should an error be made while entering frequency data (by pressing the wrong numeric key), you may abort the entry by using the **[CLR]** key and typing the frequency again followed by **[ENT]**.

6-5 Changing frequency using the [UP] [DOWN] keys and [DIAL]

The **UP / DOWN** keys provide a convenient method of frequency change, alternatively the **[DIAL]** may be rotated.

The speed at which the receiver steps up or down depends upon the STEP SIZE which is default to PROG (automatically set from the lookup table). It is possible to override the PROGRAM default using the **[STEP]** key. Available step sizes are:

NFM & AM: 5kHz, 6.25kHz, 9kHz, 10kHz, 12.5kHz, 20kHz, 25kHz, 30kHz, 50kHz & 100kHz.

WFM: 50kHz & 100kHz.

If the STEP SIZE / MODE is set to PROGRAM, the mode and channel step will automatically change as you tune through the various amateur, broadcast and utility bands.

The **[DIAL]** method of frequency selection is the most traditional approach to locating signals particularly on the short wave and medium wave bands. It provides an easy method to locate new or previously unknown frequencies or to check activity within certain frequency bands such as amateur or shortwave broadcast. The rotary tuning **[DIAL]** provides the very best “user interface” with the AR2700.

Rotating the **[DIAL]** clockwise increases frequency while rotation anti-clockwise decreases receive frequency. Being a mechanical device, it is not unusual for the **[DIAL]** to miss occasional tuning increments when rotating.

Should you **press and hold** either the **[UP]** or **[DOWN]** key for more than 1.5 seconds while the squelch is closed, the receiver will begin to MANUALLY SEARCH from the displayed frequency looking for active frequencies. Press **[MANU]** to cancel the process.

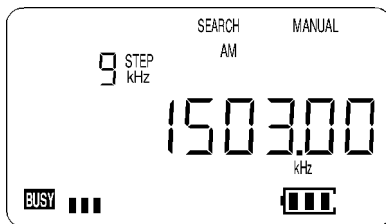

6-6 Changing frequency STEP size (PROGRAM)

The specification for channel occupancy, step (separation) and mode are decided by and allocated by departments of Government following International discussions.

Not surprisingly the allocation of frequency bands are not the same all over the world and channel separation (step) varies from band to band. As an example the channel separation (step) for the medium wave band in Europe is 9 kHz while in the U.S.A. it is 10 kHz.

For the above reasons it is necessary to alter the STEP size according to local

AR2700 operating manual

bandplan conventions. The AR2700 has been pre-programmed at the factory with all the bandplan data (specific to each market area) so that the AR2700 will automatically select the appropriate step size and mode for the frequency chosen. This greatly simplifies operation of the receiver while you are familiarising yourself with all the facilities.

The pre-programming of step size may be manually overridden so you may choose alternative settings at will or when bandplans are updated.

Should you wish to change the default step size press **[2ndF] [2]**. The legend "STEP kHz" will flash on the LCD to indicate that the receiver is expecting a change of step size. If the legend "PROG" is displayed on the top row of the LCD then the step size is currently set to the automatic PROGRAM default. It is possible to override the PROGRAM default. Available step sizes are:

NFM & AM: 5kHz, 6.25kHz, 9kHz, 10kHz, 12.5kHz, 20kHz, 25kHz, 30kHz, 50kHz & 100kHz.

WFM: 50kHz & 100kHz.

Use the **UP / DOWN** keys or **[DIAL]** to change the step size selection which is displayed to the left of the flashing "STEP kHz" legend. When you have made the new selection press **[ENT]**. Should you choose not to change the setting, press **[CLR]**.

Once you have changed the step setting from PROGRAM it may only be reinstated by selecting "PROG" in the mode input using the sequence **[2ndF] [3]** (mode).

There is just one small point to remember, the active frequency must be divisible by the step size... in 99% of cases they will be. However, should you start experimenting with different step sizes you may notice the active frequency change automatically to the nearest multiple of step size as the AR2700 calculates automatically for you, there is no need to carry a calculator!

For example, select 118.000 MHz **[1] [1] [8] [ENT]** then select a 9 kHz step size **[2ndF] [2]** choose "9.00" by rotating the **[DIAL]** and accept the selection by pressing **[ENT]**.

You will note the frequency has been corrected to 117.99900 or 118.00800 MHz (depending upon the previous direction of tuning / searching) both of which are the closest multiple of 9 kHz to 118 MHz.

Note: PROGRAM-STEP and PROGRAM-MODE are linked to the pre-programmed bandplan data. When one of the parameters is changed from the default "PROG" the bandplan will be

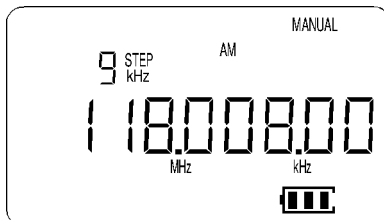
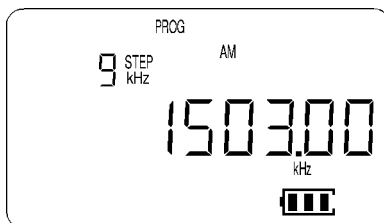

ignored. This is useful for tuning through bands with unusual modes and channel steps.

To reinstate PROGRAM step size, the receive MODE must be returned to “PROG” using the “MODE SET” input sequence which is accessed by pressing [2ndF] [3].

6-7 Changing receive mode (PROGRAM)

As mentioned earlier (section 6-6 of this manual), the specification for step and mode are allocated by departments of Government following International discussions. Like step size, the receive mode has been pre-programmed at the factory to simplify operation of the receiver while you familiarise yourself with all the facilities.

The defaults may be manually overridden at any time should you wish to select an alternative receive mode on any frequency.

To change the receive mode press [2ndF] [3].

The modes may be accessed in order: “PROG WFM FM AM”, “PROG” refers to PROGRAM MODE. When “PROG” is selected, the receive mode and step size will be selected automatically using the pre-programmed AR2700 bandplan data and FM is in fact NFM (narrow FM).

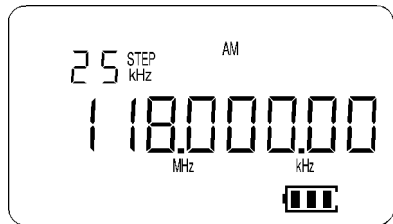

The currently selected mode will be flashing on the LCD to indicate that a new mode input is anticipated. Use the **UP / DOWN** keys or [DIAL] to make a selection, to complete the process press [ENT]. Should you decide not to change the mode setting, press [CLR].

Note: PROGRAM-STEP and PROGRAM-MODE are linked to the pre-programmed bandplan data. When one of the parameters is changed from the default “AUTO” then the bandplan will be ignored. This is useful for tuning through bands in unusual modes and channel steps.

To reinstate PROGRAM step size, the receive MODE must be returned to “PROG” using the “MODE SET” input sequence which is accessed by pressing [2ndF] [3].

Any receive mode may be selected at any frequency within the receiver's frequency coverage. Generally speaking the following modes will apply:

AM

Amplitude Modulation - Used by broadcast services throughout the world on medium wave and shortwave. AM is also used by

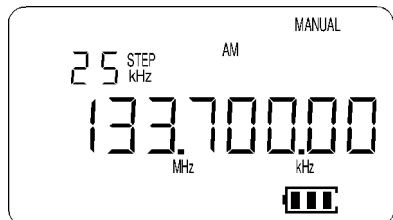

AR2700 operating manual

VHF Civil airband, UHF Military airband and some PMR (Private Mobile Radio) and utility services.

FM (NFM)

Narrow Band Frequency Modulation - this provides high quality communication for relatively short distance operation. NFM is the most common mode used above 30 MHz with the exception of the airbands. NFM is widely used on the VHF bands: VHF Marine band, 2m amateur Band (145MHz), 70cm amateur band (433 MHz), PMR (Private Mobile Radio) and utilities.

In the absence of a signal, the background white noise may appear quite loud. For ease of listening the squelch control should be rotated clockwise until the background noise just disappears, this should be carried out when no signal is present. The point where the background noise is cancelled is known as "threshold point". Do not advance the squelch control more than necessary or the receiver will appear to be desensitised and weaker signals will be missed.

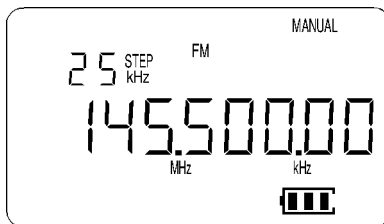

WFM

Wide band Frequency Modulation - used by VHF and UHF broadcast stations as excellent audio quality is available due to the relatively wide frequency bandwidth employed. Used only for local services such as VHF band-2 stereo (received as mono on the AR2700) and UHF TV sound channels.

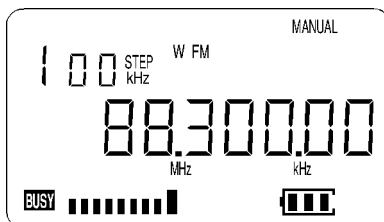

When listening in VERY strong signal locations especially when using an external aerial, the WFM I.F. amplifier may be overloaded. This will not damage the AR2700 but may result in "apparent signal loss". Should this be encountered, use the attenuator to reduce signal strength or swap to the standard telescopic whip aerial.

6-8 [ATT] Attenuator ON/OFF

The attenuator adds 10dB of signal reduction to the RF input stages of the AR2700 to reduce the possible effects of signal overloading due to connection to an external aerial or when the receiver is used in close proximity to strong transmissions.



The AR2700 has two settings for ATT (attenuator), On and Off. When the attenuator is On, the legend "ATT" appears on the top left line of the LCD.

To toggle the attenuator On/Off while in MANUAL mode press **[2ndF] [1]** the legend "ATT" confirms selection and incoming signals will be reduced in strength. To toggle On/Off again just repeat the sequence **[2ndF] [1]**, the

legend "ATT" is extinguished when the attenuator is Off.

The selection of attenuator may also be programmed into memory channels and when defining program search.

(7) Memory banks & channels

It is very convenient to store commonly used frequencies into a memory bank along with mode and attenuator status, this saves having to key the data in over and over again. Memory recall is very straight forward and quick when compared to retyping all data.

Think of memory channels as pages in a notebook each of which is numbered to identify it. Data may be written to each new page (memory channel) and each page may be overwritten with new data, they can be used over and over again.

Each memory channel may hold one frequency, mode, attenuator setting, and step data. A total of 500 memory channels are provided which are divided into 10 banks, each having 50 channels. The memory banks are identified by the numbers 0, 1, 2, 3, 4, 5, 6, 7, 8, & 9.

Examples are "000" for the first channel location in memory bank "0" and "049" for the last memory channel in memory bank "0".

"415" is the location of memory bank "4" channel "15".

The data contents of memory and search banks are held in an EEPROM so that no backup battery or capacitor is required for memory retention.

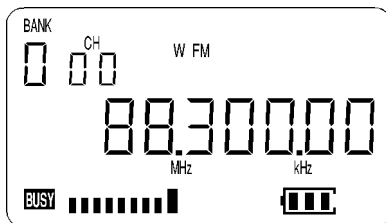

The stored data may be quickly and easily recalled, changed or deleted by re-entry, memory recall, and memory delete.

During the manufacture and testing of the receiver, various test frequencies are entered into the receiver's memory banks so the memory locations are unlikely to be completely blank.

Note: Where memory banks etc are empty the indication "- - -" is often displayed.

7-1 Storing receive data into memory - memory input in MANUAL mode

For example, to store the frequency of 88.3 MHz with the attenuator Off into memory bank "0" location "00" (000) while in MANUAL mode.

AR2700 operating manual

Start by selecting MANUAL mode (the [MANU] key) then key in the frequency of 88.3 MHz, "mode and step size" are set to the default of PROGRAM.

[MANU] to place the receiver into MANUAL mode

[8] [8] [MHz] [3] [ENT] to select the desired frequency, the mode and step size will be automatically set by the AR2700 microprocessor.

Press and hold the [ENT] key for more than 1.5 seconds to enter memory input mode.

The legend "BANK" and "CH" will appear on the LCD and start to flash to indicate that memory write is in progress. The first available empty memory bank and channel number will be displayed along with an alternating "- - -" legend and frequency to show that no data is currently stored in the memory location.

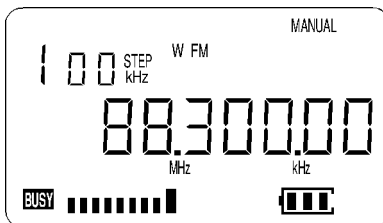

To select "BANK 0" "CHANNEL 00" type [0] [0] [0] alternatively the UP / DOWN keys will allow selection of BANK and the [DIAL] will allow selection of channel number. If data is already stored in location "000", the existing frequency will be alternatively displayed along with the new frequency to be stored... this is a warning just in case you are about to overwrite important memory data.

There is no need to first delete the contents of the memory channel, they may be simply over-written. Press [ENT] to write the new data to memory location "000". The frequency, mode, channel step and attenuator status will be stored.

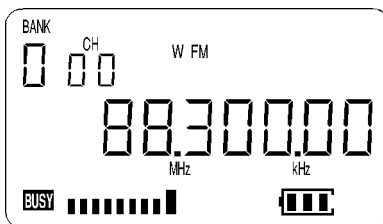

Remember, if you take too long entering data (approximately 30 seconds) the display will revert to its original condition (MANUAL mode).

At any time you may abort the memory input by pressing the [CLR] key, the display will return to MANUAL mode.

7-2 Automatic memory incrementation

Once you have written data to a memory channel, the next entry will be automatically incremented by one channel. If for example you last stored data to memory location "000" then the next time you **press and hold** the [ENT] key the set will move to memory location "001" unless it already holds data in which case it will move upward sequentially to the first available empty memory location.

If you had previously written memory data to location "315", then the microprocessor will automatically increment to location "316" or the first available empty memory channel. The microprocessor will always select the bank number last used unless otherwise specified.

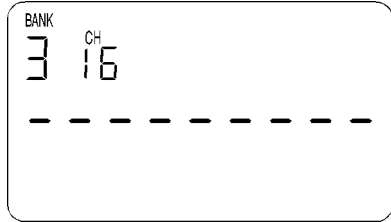

Should you wish, you may instruct the microprocessor to "offer" an alternative bank or review the current setting. While in MANUAL mode use the sequence **[2ndF] [SCAN]** (the second function being labelled as BANK. Use the **UP / DOWN** keys, **[DIAL]** or numeric keypad to select an alternative bank then press **[ENT]**.

As you may force a bank / channel location during memory write, the above facility is not essential but provides a better understanding as to how the memory system operates.

7-3 Memory recall - Recalling receive data from memory

Once receive frequency and mode data has been stored into a memory location, its retrieval is quick and simple.

For example to retrieve the frequency of 88.3 MHz which has been programmed into to memory location "000" during the example in the preceding section of this manual...

Press **[SCAN]** to place the receiver into **memory recall mode**. The legend "BANK" and "CH" appears on the top left of the LCD to confirm operation.

The receiver will display a memory channel, mode and frequency. If the desired memory channel is not immediately displayed it may be RECALLED by keying in the required location.

To recall memory channel "000" while in memory recall mode, type **[0] [0] [0]** there is no need to press **[ENT]**.

The receiver will monitor whatever memory channel first appeared when you entered memory recall mode or your new selection.

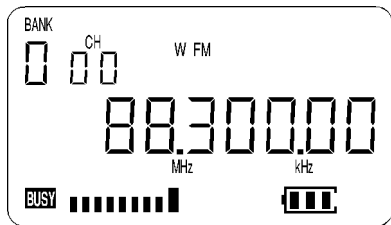

Memory channel review / hunt

The **UP / DOWN** keys and **[DIAL]** may be used to review, hunt for and select memory channels.

From MANUAL mode press **[SCAN]** to enter memory recall mode then use the **UP / DOWN** keys or rotate the **[DIAL]** to select the required memory channel.

AR2700 operating manual

This is a useful tool for reviewing memory contents and hunting for a specific channel when you forget where you stored it! Should you know the number of the required memory channel, the keypad method of memory recall will be much faster.

7-4 Transfer of memory channel to VFO

Should you wish to tune away from the memory channel and benefit from not having to re-enter the frequency, mode, attenuator setting, channel and step, the data may be quickly transferred from memory to VFO for tuning in MANUAL mode.

To transfer the currently displayed memory channel to VFO simply press **[SCAN]**. The transferred frequency may be tuned using the **UP / DOWN** keys or **[DIAL]**, the tuning step will have also been transferred from memory along with mode.

If you wish to return to the previous MANUAL VFO frequency rather than transfer memory to VFO press **[MANU]** instead of **[SCAN]**.

7-5 Memory over-write

There will come a time when you will want to change the contents of your memory banks. The easiest way to change the memory channel contents is simply to key new data over the top.

For example, let's assume that you wish to store a new frequency of 92.7 MHz into memory bank "0" location "00" (000) which has been previously used to store 88.3 MHz.

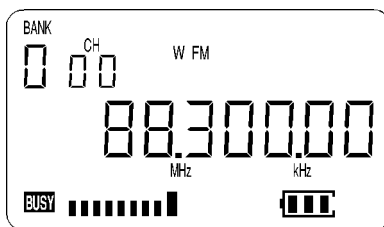

Start by selecting MANUAL mode.

[MANU] to place the receiver into MANUAL VFO mode ready for frequency entry and memory write.

Key in the new frequency of 92.7 MHz

[9] [2] [MHz] [7] [ENT] to select the desired frequency, the mode and step size will be automatically set by the AR2700 microprocessor.

Now to select and over-write an existing memory location.

Press and hold the [ENT] key for more than 1.5 seconds to enter memory input mode. The legends

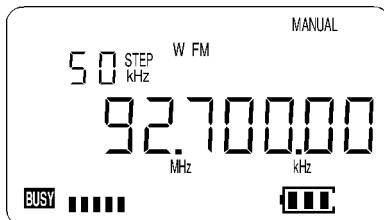

AR2700 operating manual

“BANK” and “CH” will flash to indicate that memory input is in progress.

Press **[0] [0] [0]** to select the memory location you wish to over-write (000), the stored frequency and new frequency data will alternately flash on the LCD.

Press **[ENT]** to over-write memory location “000”. The data will be stored and the display will return to MANUAL mode.

At any time you may abort the memory input by pressing the **[CLR]** key, the display will return to MANUAL mode.

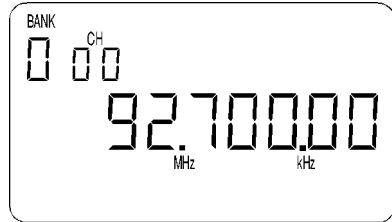

7-6 [M.DEL] - deleting individual memory channels and banks

The deletion of memory data presumes that you have previously programmed memory channels which you now wish to delete! Once you have deleted memory channel and memory bank data it cannot be restored so follow the key sequence carefully.

If the sequence **[2ndF] [7]** is keyed while in memory recall mode or when stopped on a channel during scan mode, the displayed frequency will be deleted from the memory bank and the set will move on to the next memory channel containing data (upward or downward depending upon how programmed).

For example, to delete memory channel “000” (Bank 0, CHANNEL 00). Press **[SCAN]** to enter MEMORY RECALL MODE. Key in the desired memory channel which is to be deleted **[0] [0] [0]**. Key the sequence **[2ndF] [7]** to delete memory channel “000”.

The set will remain in memory recall mode and increment to the next channel which contains data. To delete the current channel just key **[2ndF] [7]**. To return to MANUAL mode press **[MANU]**.

It is only possible **DELETE ALL THE MEMORY DATA FROM A SPECIFIC BANK** by first selecting the memory bank (using **[2ndF] [SCAN] [DIAL] [ENT]**) while in manual mode, switching the receiver Off, then switching the receiver On again while holding the **[7]** key.

For example, press **[MANU]** to place the receiver in memory recall mode. Press **[2ndF] [SCAN]** then select the desired memory bank to be deleted using the **UP / DOWN** keys, **[DIAL]** or numeric keypad. To accept the selection press **[ENT]**. Now power the set Off by **pressing and holding the [PWR] key for more than 1.5 seconds**. Switch the receiver back On by **pressing and holding the [PWR]**

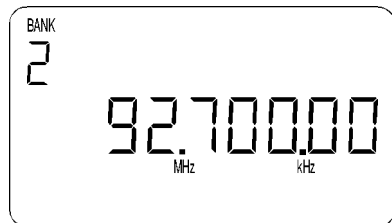

AR2700 operating manual

key for more than 1.5 seconds and at the same time holding the [7] key. Release both keys and the display will remain blank for about 2 or 3 seconds. The receiver will power up and the selected memory bank data will have been deleted. It is also possible to delete ALL programmed data by fully resetting the microprocessor, this will delete all memory, search, pass data etc.

A FULL MICROPROCESSOR reset is accomplished by holding **both the [CLR] and [ENT] keys while switching On the unit using the [PWR] key.** All memory channels, search banks, pass channels etc will be lost and blank. As a result the search and scan facilities will not operate until new data has been entered. **Note: It is quite normal for the set to take about 30 seconds to recover from a FULL reset as all data has to be deleted !!!**

(8) Priority operation

The PRIORITY feature enables you to carry on scanning, searching or monitoring while the AR2700 checks a special frequency every five seconds (default) for activity.

The priority checking is accomplished by momentarily moving to the priority frequency to see if it is "active". If activity is found, the receiver remains on the frequency until the signal disappears. If no activity is detected, the receiver returns to the VFO frequency, scan channel or search bank from where it originated.

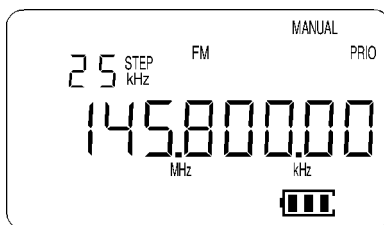

The priority facility has a large number of applications and is particularly useful for keeping an eye on a distress frequency while scanning or searching another frequency band.

Note: Depending upon the frequency and mode stored as priority, an audible "click" may be heard when the priority facility is in operation. This is quite normal and is caused by the internal switching of circuitry necessary to accomplish the frequency change as two frequencies cannot simultaneously be monitored by the receiver.

The priority mode is automatically suspended during entry of frequencies via the keypad, this prevents the receiver from changing frequency while you are busy programming.

8-1 Entering data into the priority channel

The **[PRIO]** key is used to select the priority frequency, select the sampling interval and toggle the priority watch On and Off.

The priority frequency is selected in manual mode using the key sequence **[2ndF] [PRIO]**, this is referred to as PRIORITY SET.

AR2700 operating manual

For example, to set the frequency 145.500 MHz as the priority channel:

First ensure that the receiver is in manual mode by checking that the legend "MANUAL" is displayed on the LCD or by pressing **[MANU]**.

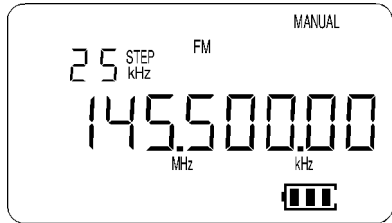

Enter the required frequency **[1] [4] [5] [MHz] [5] [ENT]**.

Transfer the displayed data to the priority channel using the key sequence **[2ndF] [PRIO]**.

8-2 Activating & deactivating priority

To toggle the priority watch On and Off press **[PRIO]**, a "PRIO" legend appears on the LCD to confirm that priority is active and the priority frequency will be periodically checked for activity regardless of whether the receiver is in MANUAL, SCAN or SEARCH mode. The priority channel will be checked for activity even if the current frequency being monitored is active.

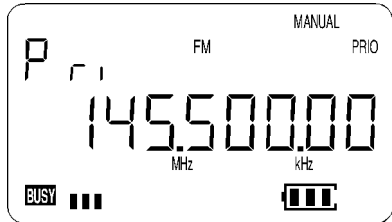

The receiver will return to its previous operation only when the activity on the priority channel has cleared and the squelch closed.

8-3 Programming priority sampling interval

The priority sampling interval is defaulted to five seconds. The programmable range is 01 to 19 seconds.

The interval time is programmed with the key sequence **[2ndF] [PRIO] with the [PRIO] key held for more than 1.5 seconds**. The value may be changed in one second increments by using the **UP / DOWN** keys or **[DIAL]** or by keying in a two digit number via the numeric keypad. The new value is accepted by pressing **[ENT]**.

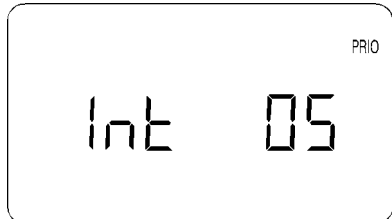

(9) SCAN - scanning memory channels & banks

The AR2700 has a **SCAN** mode whereby the contents stored in the **MEMORY CHANNELS ARE AUTOMATICALLY RECALLED AND MONITORED** very quickly for activity - scanned.

** It is important that you do not confuse SCAN and SEARCH modes. **
SEARCH mode (covered later in this manual) automatically **TUNES THE RECEIVER THROUGH ALL FREQUENCIES** between two specified frequency limits looking for active frequencies.

9-1 Starting to SCAN, considerations...

It is presumed that you have already stored your favourite and commonly used frequencies into the memory banks (as per section 7 of this manual).

A total of 500 memory channels are provided which are divided into 10 banks, each having 50 channels. The memory banks are identified by the numbers 0,1,2,3,4,5,6,7,8 & 9 and channels numbered from 00 to 49.

Keep your memory banks tidy - for best scan speed

In order to achieve the maximum scanning speed, it is advisable to keep all similar frequencies and modes grouped together within the memory banks.

The greater the frequency change between memory channels, then the further the receiver's VCO (Voltage Controlled Oscillator) has to travel and the slower the scan rates. Similarly, when many changes of mode are called for the more switching has to be accomplished and the scan speed may be reduced.

Memory channel data may be entered in duplicate into several channels. This will ensure the channel data is scanned more frequently to increase the chances of activity being detected.

Should a number of different modes and wide range of frequencies be used, then the SCAN process may be affected by noise or differences in squelch characteristic on some frequencies and modes.

9-2 SCANNING a memory bank...

For example, to SCAN the contents of memory bank "0" (channels 00-49) which have been previously stored with memory data.

There are two ways to start scanning:

Firstly

From "MANUAL" or "SEARCH" modes:

Press **[SCAN]** to enter "MEMORY RECALL" mode then press **[SCAN]** again and hold the key for more than 1.5 seconds to initiate the scan

process. Alternatively, the **UP / DOWN** key may take the place of the second [SCAN] key press.

Secondly

From “MEMORY RECALL” mode:

Press [SCAN] once holding the key for more than 1.5 seconds to initiate the scan process. Alternatively, the **UP / DOWN** key may take the place of the [SCAN] key press.

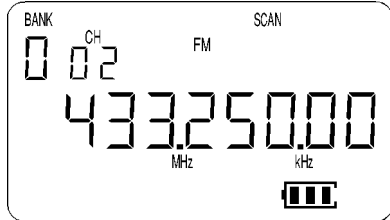

To reverse the direction of SCAN press either the [UP] or [DOWN] key or rotate the [DIAL].

The legend “SCAN” is displayed on the top row of the LCD to indicate that the SCAN process has been initiated.

When SCAN has been selected, ALL MEMORY CHANNELS WHICH CONTAIN DATA in the memory will be SCANNED irrespective of mode and frequency. ANY BLANK (empty) MEMORY CHANNELS which contain no data will be ignored (skipped).

The memory bank identifier (such as “0”) will be displayed on the left of the LCD with channel numbers changing.

When an “active” channel has been located (busy so the squelch opens) the scan process will temporarily pause on the active channel and the memory location (such as “123”) will be displayed on the LCD.

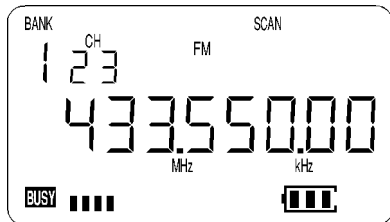

Finally when the channel becomes clear again (the signal disappears) and squelch closes, the receiver will wait for an additional two seconds (default delay) to allow for a reply on the channel before resuming the scanning process.

To force the receiver to pause on a memory channel for about 30 seconds, press [2ndF] [SCAN].

To cancel the SCAN process and return to the VFO's previous frequency without transferring the contents of the memory channel press [MANU].

9-3 Memory transfer to VFO

When stopped on an active channel or when using memory recall, press [SCAN] to transfer the memory data (frequency, mode, step & attenuator) to the VFO and the receiver will change to MANUAL MODE where you may tune

away from the channel or listen to it indefinitely until you decide otherwise.

To force the receiver to pause on a memory channel for about 30 seconds, press **[2ndF] [SCAN]**.

To cancel the SCAN process and return to the VFO's previous frequency without transferring the contents of the memory channel press **[MANU]**.

9-4 Selecting a single memory bank to scan

The memory bank which is currently being scanned will be identified on the left of the LCD (for example "0") and channel number will be changing.

Should you wish to scan a different memory bank, select a different bank using the numeric keypad and **UP / DOWN** keys.

For example, to select memory bank "1" press **[1] [UP]** or **[1] [DOWN]**. The bank number "1" will be displayed on the left of the LCD and memory bank "1" will be scanned with channel numbers changing.

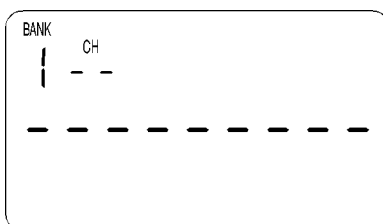

9-5 Memory bank linking

When shipped from the factory using default settings all memory banks are UNLINKED so may only be scanned on an individual basis by selecting the scan bank identifier via the numeric keypad ("0", "1", "2" etc) and then pressing the **[UP]** or **[DOWN]** keys.

It is possible to quickly link ALL memory banks together so they will be scanned as one group. Alternatively it is possible to select any number of banks to be scanned as a group such as 1, 3, 6, 7 & 9.

To LINK memory banks for scanning the "SCAN LINK" menu is used. To access the menu use the key sequence **[2ndF] [SCAN]** with the **[SCAN]** key held for more than 1.5 seconds. The legends "SCAN" "LINK" appear on the top row to show that the menu has been selected.

The top left corner of the LCD will show the legend "oF" or "on" (OFF or ON) depending upon the selection of BANK LINK. To toggle the selection of bank link, rotate the **[DIAL]** the legend will toggle appropriately.

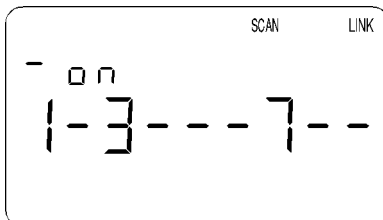
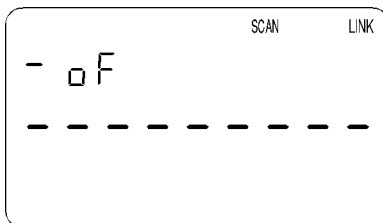

The left of the “oF / on” legend and lower row of the LCD provide places for all ten scan banks. To add more banks to the bank link list simply press the appropriate identifying scan bank number using the numeric keypad, the number legends will toggle On and Off... the legend “ - ” depicting Off (unselected).

To accept the new list and setting press [ENT].

The next time the receiver enters SCAN MODE with bank link specified as On, the legend “SCAN” “LINK” will be displayed and a group of scan banks will be scanned together as one large group.

9-6 Scanning a memory bank which is not selected in BANK LINK

It is still possible to SCAN a single deselected bank by manually bypassing the BANK LINK programming. To SCAN any deselected bank simply key the desired identifying bank number through the keypad and press either the [UP] or [DOWN] key.

Only the scan bank manually selected will be scanned.

9-7 SCAN channel PASS - CH PASS (lockout), general outline

Should the AR2700 stop on an active channel while scanning and for some reason you do not wish to monitor it any longer, simply press the UP / DOWN keys or rotate the [DIAL] to force the SCAN process to resume in the direction selected.

However, should the receiver continually stop on the same channel you may wish to PASS (lockout) the channel so that it will be skipped over when the bank is next scanned.

Memory scan channels may be PASSED (lockout) either when the receiver stops in scan mode (when they are active and the receiver has stopped scanning) or by recalling them in memory recall mode.

9-8 Memory scan PASS while scanning

To PASS a channel when scanning, wait for the channel to become active then press [2ndF] [8]. The legend “CH PASS” will be added above and to the left of the LCD to indicate that the channel has been locked out and the scan process will move on to the next channel. **This process will happen so quickly that you will not see the “CH PASS” legend being added. However, should the memory channel subsequently be recalled using memory recall, the “CH PASS” legend will be displayed to signify CHANNEL PASS.**

9-9 Memory CHANNEL PASS & review using Memory Recall mode

Memory scan channels may be “tagged” for “PASS”, un-tagged or reviewed using memory recall mode.

AR2700 operating manual

Press **[SCAN]** to place the receiver into **memory recall mode**. The legend “BANK” and “CH” appears toward the top left of the LCD to confirm selection of memory recall mode.

The receiver will display a memory channel, mode, frequency, attenuator and CHANNEL PASS status.

If the desired memory channel to be PASSED (locked out) is not immediately displayed, the **UP / DOWN** keys or **[DIAL]** may be used to review specific memory scan channels. Alternatively the memory channel location may be quickly recalled by keying in the required location using the keypad.

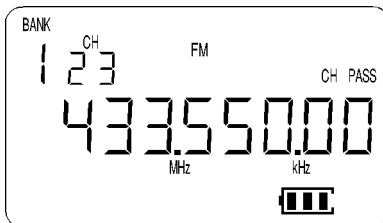

For example, to recall memory channel “123” type **[1] [2] [3]** there is no need to press **[ENT]**. When a locked out memory channel has been selected, the legend “CH PASS” appears above and to the right of the frequency display.

To change the status of CHANNEL PASS (toggle CH PASS On/Off) use the key sequence **[2ndF] [8]**.

**Lockout = “CH PASS”
(will not be scanned)**

**Unlocked = “no legend”
(will be scanned)**

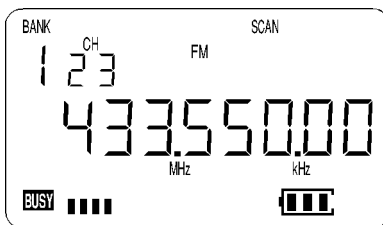

The receiver will monitor whatever memory channel is displayed in memory recall mode when manually selected regardless of the CHANNEL PASS status.

(10) DELAY and PAUSE facility in scan and search modes

Two user programmable timers are provided for optimising the AR2700 to suit certain applications. These timers are “global” and affect every scan and search mode.

10-1 DELAY time

The DELAY parameter affects the time the receiver will remain on an active channel in scan and search mode once the received signal has disappeared and the squelch closed.

This is particularly useful for customising how long the receiver will wait for a reply before continuing to scan. For example, when communications are

passed back-and-forth between a control tower / aircraft which may take a few seconds. If you are scanning duplex channels then a small delay or no delay at all may be preferable.

The limits are 0.0 to 9.9 seconds with 0.0 being interpreted as DELAY OFF. **The default is 2.0 seconds.**

To access the menu to change the delay time press **[2ndF] [6]**. The legend "SEARCH SCAN" appears on the top line of the LCD with the flashing legend "DELAY" centrally positioned to the left of a two digit number, at default this number will be **2.0**

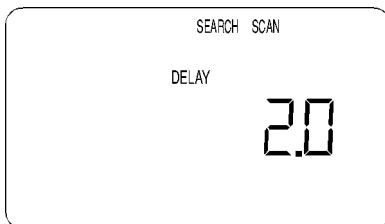

The value may be changed by keying in a two digit number via the numeric keypad (the decimal is automatically entered by the microprocessor) or the **UP / DOWN** keys or **[DIAL]** may be used to change the value in 0.1 second increments. Press **[ENT]** to accept the new value.

Note: Setting DELAY to 0.0 turns the delay OFF. Under this condition, the receiver may start to scan before the transmission has finished due to signal level changes such as mobile flutter or signal fading.

10-2 PAUSE time

The PAUSE parameter determines how long the receiver will remain on an "active" channel before resuming scanning channels or searching.

This is useful if you wish to gain a **picture** of what is happening without the receiver being tied to a busy frequency for long periods of time (such as when monitoring active amateur band repeaters etc). PAUSE saves you having to manually intervene to force the scan or search process to continue or use PASS channels.

The limits are 01 to 99 seconds with the **default being 05**. It is also possible to switch PAUSE Off.

If the sequence **[2ndF] [9]** is keyed the **global PAUSE** facility will be engaged and the legend "PAUSE" will be displayed on the LCD. To toggle the pause facility to Off simply repeat the key sequence **[2ndF] [9]**.

To program the pause delay time, key the sequence **[2ndF] [9]** and hold the **[9]** key for more than **1.5 seconds**. The value may be changed by keying in a two digit number via the numeric keypad or the **UP / DOWN** keys or **[DIAL]** may be used to change the value in one second increments. Press **[ENT]** to accept the new value.

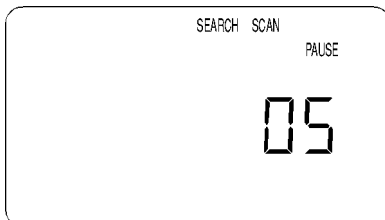

(11) SEARCH - manual & program search banks and PASS

The AR2700 has a **SEARCH** mode whereby an upper and lower frequency limit may be defined and the receiver instructed to look for activity on **all frequencies in selected step size and mode** in an upward or downward direction.

The mode and channel step will change automatically when set to the default of PROGRAM "PROG" but data may be specified specifically if preferred.

** It is important that you do not confuse SEARCH and SCAN modes. **

SEARCH mode automatically **TUNES THE RECEIVER THROUGH ALL FREQUENCIES** between two specified frequency limits looking for active frequencies. **SCAN** mode automatically recalls and monitors SPECIFIC SPOT FREQUENCIES which have been stored into memory.

The great advantage of SEARCH over manual tuning is that it is so fast! There are many different options available for SEARCH mode which will be explained in this section.

The search instructions may be programmed into banks. There are a total of 10 programmable search banks so that data entry and recall is simple and efficient.

Continuously active or busy frequencies such as amateur band repeaters may be PASSED (skipped) and active frequencies stored to memory.

When the receiver stops on a genuine active frequency during search, the **[SRCH]** key may be pressed to transfer the frequency to VFO where it may be monitored for long periods of time or tuned. Pressing **[ENT]** for more than **1.5 seconds** will initiate the process of storing the frequency into a memory channel.

Limitations of SEARCH mode

SEARCH mode is extremely effective for AM & NFM use in the VHF and UHF bands. Searching the shortwave bands is usually ineffective due to the relatively high background and in-band noise especially when propagation conditions are good and bands open.

11-1 Manual SEARCH

The simplest form of SEARCH is achieved by programming a frequency while in MANUAL MODE then **press and hold the [UP] or [DOWN] key for more than 1.5 seconds**. The legend "SEARCH" and "MANUAL" will be displayed on the LCD to indicate that a MANUAL SEARCH is in progress and the set will start to tune upwards or downward depending upon which key had been used.

AR2700 operating manual

The search process takes place from the displayed frequency using the receive mode and step size displayed. If the default mode of PROGRAM "PROG" has been selected, then the receive mode and channel step will change automatically depending upon the automatic bandplan data programmed into the AR2700 during manufacture.

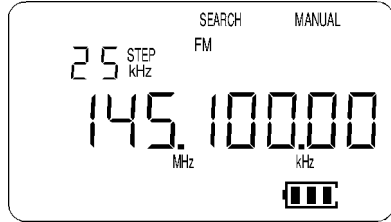

Example of manual search

For example, to search manually from 145.000 MHz key [1] [4] [5] [ENT] in **MANUAL** mode then press and hold the [UP] key for more than 1.5 seconds.

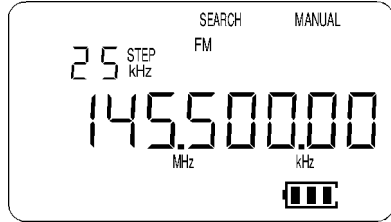

Changing the direction of manual search

Depending upon the key used to initiate the MANUAL SEARCH, the receiver may be automatically searching upward or downward. The direction of search may be reversed by rotating the [DIAL] or using the UP / DOWN keys.

Moving on from active frequencies

Should the receiver stop on an active frequency during manual search, you may force the manual search process to continue by pressing the UP / DOWN keys or rotating the [DIAL].

To cancel manual search and transfer to manual mode

To cancel manual search press [MANU], the current displayed frequency will be transferred to the VFO frequency in manual mode where it may be monitored or tuned.

Writing active frequencies to memory and continuing manual search

If an interesting active frequency is found while in manual search mode, it may be written to a memory channel.

Press and hold the [ENT] key for more than 1.5 seconds to enter memory write mode.

The legend "BANK" and "CH" will be displayed in the upper left corner of the LCD to confirm that memory write is in progress.

The first available empty memory location will automatically be offered. To write the frequency into this memory location simply press [ENT].

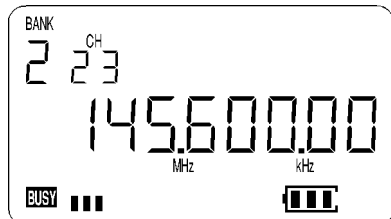

AR2700 operating manual

Alternatively you may choose a new memory location using the **UP / DOWN** keys, **[DIAL]** or by keying in a three digit memory location. To accept the data and write to memory press **[ENT]**.

11-2 FREQUENCY PASS in search mode

It is possible to PASS frequencies (lockout - frequencies that you wish to be skipped and not searched such as blank carriers) during manual search. There are a total of 50 PASS channels provided by the AR2700.

PASS a frequency

To PASS a frequency during manual search press **[PASS]**. The frequency will be automatically entered into the first available PASS CHANNEL and the set will continue to search once again.

If the set fails to respond to the **[PASS]** key then all 50 PASS channels have probably been used up and you will need to delete some in order to make more channels available.

Reviewing the PASS list

To review the pass list **press and hold the [PASS] key for more than 1.5 seconds while in MANUAL or SEARCH mode**. The legends "CH" and "PASS" will be flashing on the LCD to indicate that the pass list has been accessed and the first frequency in the list will be displayed along with it's pass channel number "00".

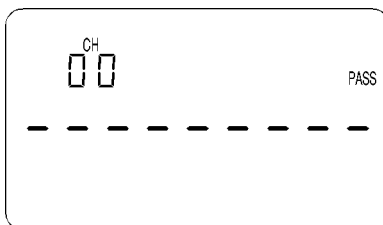

The list may be reviewed using the **UP / DOWN** keys or by using the **[DIAL]**.

Deleting frequencies from the PASS list

A pass frequency may be deleted by first displaying the selected frequency in the pass list then keying **[0] [ENT]**. The frequency will disappear and the list will "shuffle down" to fill the gap which has been made.

Alternatively it is possible to delete the entire pass list in one go! To achieve this first switch the receiver Off. Switch the receiver back on **while holding both the [PWR] and [8] keys for more than 1.5 seconds**. Release both keys and the display will remain blank for about 2 of 3 seconds. The receiver will then power up as usual but the entire pass list data will have been erased.

Manually adding frequencies to the PASS list

Frequencies may be manually added to the pass list by first displaying the chosen pass channel then **keying in a frequency followed by [ENT]**, the pass list will increment to the next channel. To escape from the pass list press **[CLR]**.

AR2700 operating manual

11-3 Program search banks

It is possible to save parameters of frequency, mode, step and attenuator into any of the 10 program search banks for easy access at any time.

The program search banks (referred to simply as search banks) are identified by the numbers 0, 1, 2, 3, 4, 5, 6, 7, 8 & 9.

For your convenience the microprocessor (depending on world market area) may have been pre-programmed with search banks at the factory, these being specifically chosen for each market area.

An example of typical programming is as follows (in these examples the mode & step are taken from the PROGRAM automatic bandplan data). The sequence may appear in a different order:

1	118.000	to	138.000	MHz	(Civil airband)
2	225.000	to	410.000	MHz	(Military airband)
3	410.000	to	425.000	MHz	(USAF)
4	156.000	to	163.000	MHz	(VHF marine band)
5	88.000	to	105.000	MHz	(BAND 2 broadcast)
6	145.200	to	145.775	MHz	(2M amateur band)
7	433.000	to	433.600	MHz	(70cm amateur band)
8	1297.000	to	1298.000	MHz	(23cm amateur band)
9	71.000	to	87.000	MHz	(Low band PMR)
0	163.400	to	225.000	MHz	(VHF PMR)

Starting program search

Assuming that the AR2700 is pre-programmed with similar data to that shown above, to initiate PROGRAM SEARCH press **[SRCH]**. The legend "SEARCH" appears on the top row of the LCD to confirm selection.

To select a specific search bank press the key corresponding to the desired search bank identifier. For example, to search bank "3" press **[3]** while in search mode.

The lowest frequency in the bank will first appear on the LCD and will change in an upward direction. Use the **UP / DOWN** keys or **[DIAL]** to reverse the direction of search.

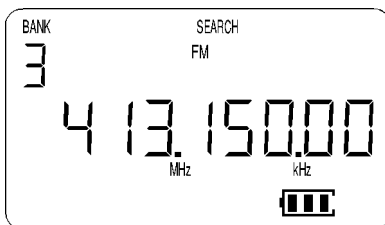

Forcing the program search passed busy frequencies

Should the receiver stop on an unwanted active frequency, press the **[UP] / [DOWN]** keys or **[DIAL]** to force the search process to continue.

* Also refer to section 11-2 of this operating manual (frequency pass).

AR2700 operating manual

To cancel program search

To cancel program search press **[MANU]** and the display will return to the original VFO frequency in MANUAL mode.

Transfer of an active frequency to VFO

Should the search process stop on an interesting active frequency, you may stop the search process and transfer the frequency to VFO by pressing **[SRCH]**.

The receiver will monitor the active frequency and may be tuned using the **[DIAL]** or **UP / DOWN** keys.

Writing active frequencies to memory

If an interesting active frequency is found while in program search mode, it may be written to a memory channel.

Press and hold the [ENT] key for more than 1.5 seconds. The AR2700 will enter MEMORY WRITE MODE, the legends "BANK" and "CH" will flash to indicate that the receiver is expecting you to accept the memory location or choose a new location. Initially the first available empty memory channel will be offered. If you prefer to store the data into a different memory channel use the **UP / DOWN** keys, **[DIAL]** or numeric keypad to make a new selection.

To accept the memory location and write data to the chosen memory location press **[ENT]**.

Note: The receiver will return to PROGRAM SEARCH MODE but will start at the lowest frequency of the program search range and start searching again. For this reason it is recommended that only a relatively small range of frequencies are searched / analysed at any time. If this proves a nuisance, then use **MANUAL SEARCH** mode so that the search process continues from the currently displayed frequency. Refer to section 11-1 of this operating manual.

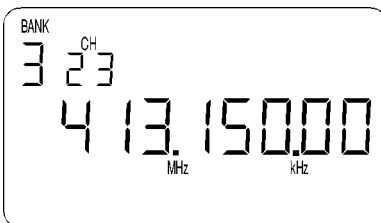

11-4 Reviewing program search upper and lower limits

It is very easy to review the upper and lower frequency limits or program search banks to make their identification easier.

When in program search mode (the "SEARCH" legend displayed on the LCD) press **[2ndF] [SCAN]** to review the upper and lower limits of the program search banks. This method is preferable to the PROGRAM SEARCH MENU as you cannot accidentally over-write the program search bank contents.

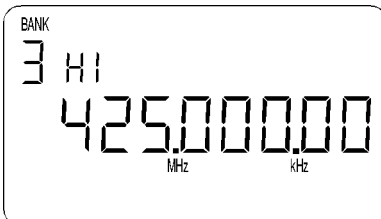

The flashing legend “BANK” appears in the top left corner of the LCD with the current bank number shown directly underneath. The UPPER and LOWER program search bank limits will alternate on the LCD along with the legends “HI” and “Lo”.

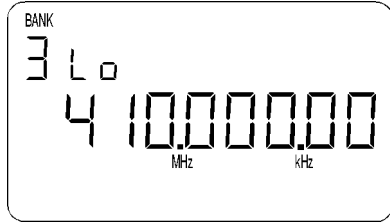

To view the limits of a different program search banks use the **UP / DOWN** keys or **[DIAL]** to make the selection.

To return to program search mode press **[ENT]** otherwise the receiver will return to program search mode automatically after about 30 seconds. Alternatively should you wish to return to a different program search bank, press a numeric key corresponding to the search bank required (no **[ENT]** is required).

11-5 Programming and reprogramming PROGRAM SEARCH BANKS

You may wish to specify your own frequency limits or modes for program search banks, you may also reprogramme any which may be already pre-programmed. There are 10 program search banks in total identified as banks 0, 1, 2, 3, 4, 5, 6, 7, 8 & 9.

Example of reprogramming a search bank - “5”

For example, to reprogramme the data contents of search bank “5” to the following parameters:

Low frequency	433.000 MHz
High frequency	433.600 MHz
Receive mode	FM
Step size	25 kHz steps
Attenuator	OFF

Starting to reprogramme

Use the key sequence **[2ndF] [SRCH]** to initiate the process of programming a search bank. The flashing legend “SEARCH” indicates that reprogramming is in process.

Selecting the bank

Use the **UP / DOWN** keys, **[DIAL]** or numeric keypad to select the desired program search bank for reprogramming. Press **[ENT]** to accept the selected bank.

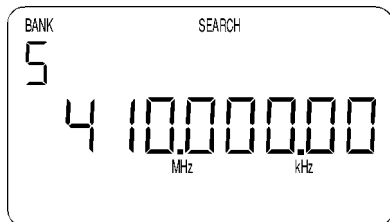

In this example press **[5] [ENT]**

Selecting receive mode

The current upper and lower frequencies will alternate on the LCD along with step size and receive mode, this helps acknowledge that the correct bank has

AR2700 operating manual

been selected. If no frequency data is currently stored the legend “- - -” will be displayed.

Use the **UP / DOWN** keys or **[DIAL]** to select the required receive mode. If the alternating frequency is distracting, press one of the numeric keys so that the display “- - -” is presented.

If “PROG” is selected then the receive mode and step will be taken from the automatic bandplan data, in this case the selection of step will be skipped.

To accept the choice of receive mode press **[ENT]**.

In this example select “**FM**” then press **[ENT]**

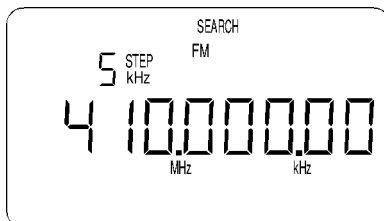

Selecting step size

If the mode selection has previously been made as “PROG” then the receive mode and step will be taken from the automatic bandplan data and this item will be skipped.

To select the step size use the **UP / DOWN** keys or **[DIAL]**. The choices are as follows:

NFM & AM: 5kHz, 6.25kHz, 9kHz, 10kHz, 12.5kHz, 20kHz, 25kHz, 30kHz, 50kHz & 100kHz.

WFM: 50kHz & 100kHz.

To accept the choice press **[ENT]**.

In this example select “**25kHz**” then press **[ENT]**

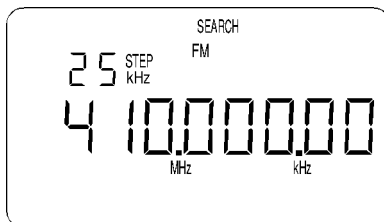

Selecting attenuator On / Off

Use the **UP / DOWN** keys or **[DIAL]** to select the appropriate setting for the attenuator. On is when the receiver is least sensitive, Off is when the receiver is most sensitive. The legends are “on” or “oFF”, the usual setting is Off.

Other legends at this time will be a flashing “ATT”, steady “PROG” and flashing “SEARCH”.

To accept the choice of attenuator press **[ENT]**.

In this example select “**oFF**” then press **[ENT]**

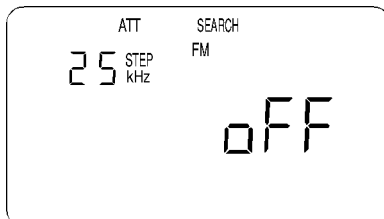

Setting the LOWER frequency limit

The legends at this time are a steady "PROG" and flashing "SEARCH". To the left of the frequency readout is the legend "Lo" to indicate that the lower frequency limit is required.



Enter the lower frequency then press [ENT].

In this example type [4] [3] [3] [MHz] [ENT]

Setting the UPPER frequency limit

The legends at this time are a steady "PROG" and flashing "SEARCH". To the left of the frequency readout is the legend "HI" to indicate that the upper frequency limit is required.

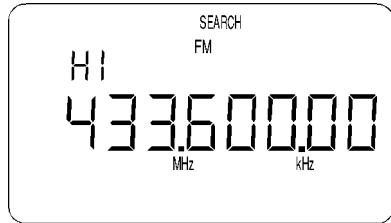

Enter the upper frequency then press [ENT].

In this example type [4] [3] [3] [MHz] [6] [ENT]

THE REPROGRAMMING IS NOW COMPLETE AND THE RECEIVER WILL ENTER PROGRAM SEARCH MODE AND WILL START SEARCHING.

Notes on program search bank programming

There is no need to delete program search bank data before programming. If data is already present, it may simply be over-written.

Should you initiate program search bank programming while in search mode, the receiver will return to search mode, similarly with scan and manual mode... within reason, the receiver will return to where it left off.

Aborting program search programming

To ABORT the the process of programming a search bank at any time press [CLR].

11-6 Program search bank linking

When shipped from the factory using default settings all search banks are UNLINKED so may only be searched on an individual basis by selecting the search bank identifier via the numeric keypad ("0", "1", "2" etc).

It is possible to quickly link search banks together so they will be searched as one group (handy for breaking down a large frequency range into smaller more manageable ranges). It is possible to select any number of banks to be scanned as a group such as 2, 4, 5, 6 & 9.

To LINK ALL search banks the “SEARCH LINK” menu is used. To access the menu use the key sequence [2ndF] [SRCH] with the [SRCH] key held for more than 1.5 seconds. The legends “SEARCH” “LINK” will appear on the top row to show that the menu has been selected.

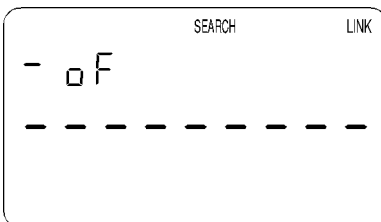

The top left corner of the LCD will show the legend “oF” or “on” (OFF or ON) depending upon the selection of BANK LINK. To toggle the selection of bank link, rotate the [DIAL] and the legend will toggle appropriately.

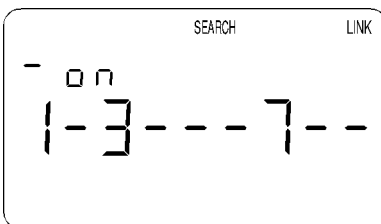

The left of the “oF / on” legend and lower row of the LCD provide places for all ten search banks. To add more banks to the bank link list simply press the appropriate identifying search bank number using the numeric keypad, the number legends will toggle On and Off... the legend “ - “ depicting Off (unselected).

To accept the new list and setting press [ENT].

The next time the receiver enters PROGRAM SEARCH MODE with bank link specified as On, the legend “SEARCH” “LINK” will be displayed and a large group of search banks will be sequentially searched together as one large group.

11-7 Searching a search bank which is not selected in BANK LINK

It is still possible to SEARCH a single deselected bank by manually bypassing the BANK LINK programming. To SEARCH any deselected bank simply key the desired identifying bank number through the keypad while in search mode.

Only the search bank manually selected will be searched.

(12) Sleep timer - automatic power Off



The AR2700 is fitted with a SLEEP timer which is capable of automatically switching the receiver Off after a prescribed time period.

This can be useful if you use the receiver at bedtime, listening to local radio amateur repeaters etc as you slip off into sleep. Alternatively if you leave the house while the receiver is still monitoring, you can be confident that the receiver will soon switch Off so saving you having to immediately recharge the NiCad batteries upon your return to home.

12-1 Enabling SLEEP time

If the sequence [2ndF] [5] is keyed, the sleep timer is enabled. A clock legend will be displayed on the lower right of the LCD and the receiver will automatically switch Off after the programmed sleep time has expired. The default is 60 minutes.

To de-activate the sleep timer key the sequence [2ndF] [5] a second time, the clock legend will be removed from the LCD.

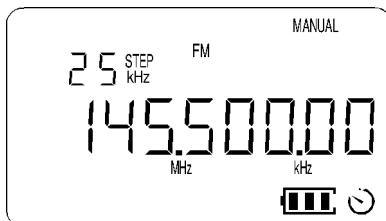

12-2 Defining the SLEEP time period

The SLEEP timer may be programmed between 1 and 120 minutes in one minute increments. Use the key sequence [2ndF] [5] with the [5] key held for more than 1.5 seconds. The new value may be keyed through the numeric keypad or the UP / DOWN keys may be used or the [DIAL]. To accept the new value press [ENT].

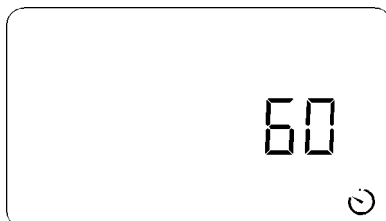

(13) Optional VOICE recording facility



The AR2700 may optionally be fitted with an internally fitted VOICE recording chip (RU2700) enabling digital recording of 20 seconds of transmission. The advantage of this method of record is that the record facility is always available and everything is self contained and extremely portable.

The recording may be re-played over and over again and is not lost even where the power is switched Off or batteries exhausted.

13-1 Initialising the record option

To initiate the recording facility after installation of the RU2700 optional chip switch the receiver Off. Switch the receiver back On again by **holding both the [PWR] key and [6] key for more than 1.5 seconds**. Release both keys and a selection menu will be presented.

If the receiver refuses to enter the setup menu switch Off, leave the receiver for a few minutes and try again. Failing this, power the receiver On while holding the [0] key then release, power Off and try again.

The "REC" legend will be flashing to indicate that the options menu has been

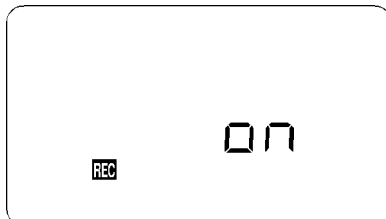

AR2700 operating manual

selected. The selection of RECORD On and Off is made using the [DIAL] with legends "oFF" and "on" confirming selection. To accept the displayed selection press [ENT]. The set will quickly display all LCD segments then power On as normal. The option will now have been added or removed from the keypad operation as appropriate.

Note: When in the setup menu, the UP / DOWN keys toggle between the RECORD and DESCRAMBLE option setup routines.

13-2 Recording

To make a recording, tune the receiver to an active frequency and key the sequence [2ndF] [4] with the [4] key held for more than 1.5 seconds, the legend "REC" will be displayed on the LCD and the current displayed frequency will be recorded for 20 seconds (presuming that the optional record chip has been fitted).

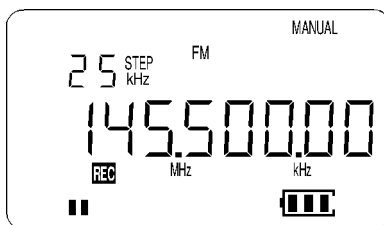

The signal meter acts as a "progress meter" to illustrate how much record and play back time has elapsed.

The record facility may be used in MANUAL mode, or even when scanning or searching.

13-3 Play back

To replay a previously recorded transmission, key the sequence [2ndF] [4]. The legend "PLAY" will be displayed on the LCD and the 20 second digital recording will be replayed (presuming that the optional record chip has been fitted). If the optional chip has not been fitted then white noise will be heard.

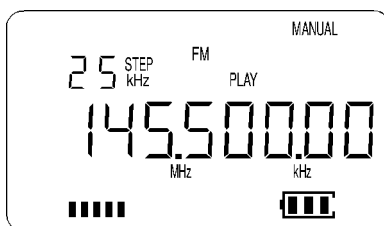

The signal meter acts as a "progress meter" to illustrate how much record and play back time has elapsed.

(14) Remote control using a computer (RS232C)

The AR2700 is capable of remote control using a computer such as an IBM compatible and control software. An adaptor (IF-ADP) and small external interface (CU8232) and lead are required and available as options.



Further information will be provided with the optional CU8232 interface unit.

14-1 Setting the RS232 parameters

The RS232 parameters may be altered using the SERIAL menu. This menu is accessed with the sequence **[2ndF] [UP] with the [UP] key held for more than 1.5 seconds.**

The flashing legend "SERIAL" appears on the LCD to indicate that the RS232 menu has been accessed.

The RS232 baud rate is indicated on the left of the LCD (for example 9600 bps) and may be changed to 4800 or 2400 bps using the **[DIAL]**. The baud rate will be displayed in sequence on the LCD.

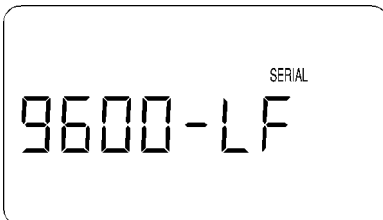

It is also possible to add a LINE FEED to the data, this is accomplished by using the **[UP]** or **[DOWN]** keys. The legend "LF" to the right of the baud rate indicates when the LINE FEED has been added.

To accept the currently displayed value press **[ENT]**.

Due to the characteristics of the EEPROM and receiver circuits, the choice of RS232 communications speed between the receiver and computer may not greatly affect the operational efficiency. Of course, correct operation will only be achieved when the parameters are all matched between the computer and AR2700.

(15) Clone (copy) data between two AR2700 receivers

It is possible to clone (copy) ALL data from one AR2700 to another AR2700 receiver. This is a useful facility when two friends each have the AR2700 receiver and wish to share data.

The optional adaptor (IF-ADP) and interface (CU8232) is required. Further information will be provided with the optional adaptor and interface.

15-1 Transferring data by CLONE

Connect the two AR2700 receivers together using the optional adaptor (IF-ADP) and interface (CU8232) using the cables provided with the options.

Decide which receiver is going to SEND the data and which is going to RECEIVE. You cannot specify what data is to be transferred, ALL data must be sent.

The process of copying data is initiated using a menu which is accessed with the sequence **[2ndF] [UP]**.

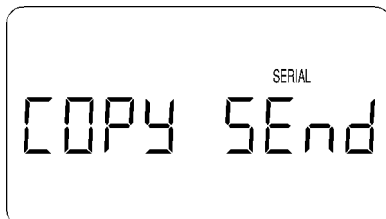

AR2700 operating manual

The flashing legend "SERIAL" appears on the LCD with a larger display of "COPY SEnd". The **UP / DOWN** keys or **[DIAL]** may be used to select SEND MODE "COPY SEnd" or RECEIVE MODE "COPY rCV".

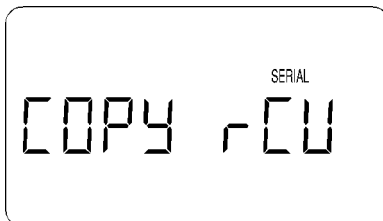

First select the AR2700 which will RECEIVE the data and press **[ENT]** to accept the COPY RECEIVE command.

The first segment of the signal meter will appear to confirm that command has been accepted and the receiver is ready to accept data via the RS232 port.

Secondly select the AR2700 which will SEND the data and press **[ENT]** to accept the COPY SEND command. The first segment of the signal meter will appear to confirm that command has been accepted and the receiver will start to send data via the RS232 port.

Both AR2700 signal meters will increase to indicate the transfer of data between receivers, the transfer will take several minutes. When the process is complete the LCD display will return to normal operation.

Note: Ensure that the batteries are fully charged before attempting data clone otherwise data corruption may take place. It may be a good idea to power the receiver from a DC supply while copying data.

(16) Trouble shooting

Should you experience problems with the receiver "apparently doing something unexpected", simply switch Off the receiver using the main power switch and leave it for about 10 seconds. Switch the receiver back on again and check if the problem has been cleared.

Failing this, try removing one battery (or disconnecting the power), leave the set for about one minute, re-fit the battery and try again.

If the receiver still refuses to respond as expected, try a microprocessor reset as shown on section 16-1 of this operating manual.

16-1 Microprocessor reset

Should the receiver still refuse to operate correctly you may RESET the microprocessor using one of the following three sequences (try method 1 first then method 2 then method 3).

Method 1 - [CLR] key

Should you experience a programming / operational problem with the AR2700, you may "soft" reset the microprocessor by holding the **[CLR]** key while

powering up the receiver. Your memory bank and search bank data will remain intact but any linked banks, frequency pass data etc will be lost.

Method 2 - RESET switch, left side panel

A “soft” microprocessor reset may also be accomplished by momentarily pressing the reset switch located on the left hand cabinet using a pointed utensil such as a pin, small screwdriver, sharp pencil etc. It does not matter if the receiver is switched On or Off at the time.

Your memory bank and search bank data will remain intact but any linked bank data etc will be lost.

Method 3 - FULL reset [CLR] + [ENT] keys

DO NOT USE THIS KEY SEQUENCE UNLESS ABSOLUTELY NECESSARY.

A FULL MICROPROCESSOR reset is accomplished by holding **both the [CLR] and [ENT] keys while switching On the unit using the [PWR] key.** All memory channels, search banks, pass channels etc will be lost and blank.

As a result the search and scan facilities will not operate until new data has been entered. **Note: It is quite normal for the set to take about 30 seconds to recover from a FULL reset as all data is being deleted !!!** Often there is no external indication that a reset is in progress so be patient, following a FULL reset the receiver will power On and the display will show 80 MHz.

16-2 Other possible operational problems

Signals are weak

Check that the attenuator is not switched On (the legend “ATT” is not displayed on the top line of the LCD).

Ensure the correct receive mode is being used (AM for airband, NFM for point to point communications - not WFM etc).

Frequency jumps a few kHz

If you have altered the tuning step size for VFO or SEARCH mode, remember that the receiver frequency must be divisible by the step size. If it is not, the AR2700 will correct the displayed frequency to the nearest kHz which is divisible.

Frequencies and memory channels are skipped

Ensure that the frequencies are not in the PASS list and memory channels not locked out “CH PASS” by reviewing memory contents in memory recall.

AR2700 operating manual

The receiver stops on blank carriers

The receiver may stop on blank carriers. It may be that these are true transmissions (you can usually remove the aerial to determine this).

Alternatively the AR2700 (like all receivers) will produce spurious signals in certain places such as 129.600 MHz, 144.000 MHz and 158.400 MHz as examples. You may use the PASS facility to reduce their annoyance to a minimum.

The display blinks and changes

Ensure that the PRIORITY facility is not engaged. If it is, the legend "PRIO" will be displayed on the second line of the LCD toward the upper right hand corner.

Receiver does not switch on

In using NiCad batteries, charge them using the charger provided or connect the receiver to a vehicle cigar lighter socket using the DC lead provided. If you are using dry batteries, replace them with a fresh set.

If this does not help

If the above does not help, please contact your supplier for assistance.

16-3 Other LCD indications and error messages

"BEEP" & "BOOP"

The keypad usually produces a high pitch "beep" when the correct key or sequence is followed. Should an inappropriate key be pressed, a lower pitch "BOOP" will be produced. It is possible to switch the beep & boop On/Off using the key sequence [2ndF] [PASS].

A "boop" will be emitted if you attempt to scan or search when no data has been programmed.. following a FULL microprocessor reset for example.

BATTERY LOW special indicator

The special on-screen battery indicator provides a constant indication of battery level. Once the unit indicator drops to "one block" then it is time to recharge or replace the batteries as the unit may stop functioning at any time.

"PLL Err" - PLL ERROR

This indicates that the PLL (Phase Lock Loop) has unlocked. This is the system used by the receiver to select and change frequency. Ensure that the frequency is within the receiver's specified frequency coverage of 500 kHz (0.5 MHz) to 1300 MHz.

A PLL ERROR message may also be displayed if the batteries are near to exhaustion.

16-4 Special functions

The AR2700 has a number of “special functions”, it is highly recommended that these are left where set during manufacturer. However, the defaults are listed here for information.

First power the receiver **while holding both the [PWR] key and [0] key for more than 1.5 seconds**, release the keys and switch the receiver Off again using the [PWR] key.

Squelch detect

Switch the receiver On again **while holding both the [PWR] key and the [2] key for more than 1.5 seconds**. This is the menu for setting the SQUELCH DETECT TIME. The default is **15** and the acceptable range is 0 - 30. The **UP / DOWN** keys, [DIAL] or numeric keypad may be used to change the setting. The [ENT] key is used to accept the changes or [CLR] to abort.

PLL lock detect time

Switch the receiver On again **while holding both the [PWR] key and the [3] key for more than 1.5 seconds**. This is the menu for setting the PLL LOCK DETECT TIME. The default is **04** and the acceptable range is 0 - 30. The **UP / DOWN** keys, [DIAL] or numeric keypad may be used to change the setting. The [ENT] key is used to accept the changes or [CLR] to abort.

Intermediate frequency selection

Switch the receiver On again **while holding both the [PWR] key and the [5] key for more than 1.5 seconds**. This is the menu for setting the INTERMEDIATE FREQUENCIES - **DO NOT ADJUST THIS !!!**
The values are keyed in via the numeric keypad.

The defaults are:

600	70.000.00
601	108.000.00
602	147.000.00
603	470.000.00
604	1013.000.00
605	1300.000.00
605	- - - - -

(17) Optional accessories

RU2700

An optional VOICE RECORDING chip is available. When internally fitted, it is possible to record and play back 20 seconds of activity.

SC2700

An optional soft leatherette case is available to add protection to the plastic cabinet when used on the move.

IF-ADP & CU8232

RS232 adaptor and interface unit is required for computer control and clone (copy) data between two AR2700 receivers. For computer control a standard serial lead is also required.

DA900 whip aerial

Flexible whip aerial for VHF/UHF approximately 25cm in length, ideal for portable use especially when the receiver is to be carried in a pocket.

MA500 mobile aerial

Compact mobile whip aerial for VHF/UHF on a magnetic base with a few metres of coaxial cable and ready terminated with a BNC plug.

LA320 loop aerial

Desktop active loop aerial for portable operation away from a base aerial such as when while travelling on business or holiday. Frequency coverage is 1.6 to 15 MHz with optional elements to cover 0.2 to 0.54 MHz and 0.54 to 1.6 MHz.

WA7000 wide band active whip aerial

Compact aerial designed for installation where space is a problem. The WA7000 is active on the lower frequency band 30kHz to 30MHz and passive on the higher band between 30MHz to 2000MHz.

DA3000 VHF-UHF discone aerial

16 element VHF - UHF discone aerial with usable coverage of 25 MHz to 2000 MHz. Supplied with cable and connectors etc.

ABF125

VHF civil airband filter to reduce the chances of breakthrough especially from powerful VHF band-2 transmitters.

(18) Specification

Frequency coverage:	500 kHz - 1300 MHz no gaps (input accepted from 100 kHz)
Receive modes:	NFM, WFM, AM
Sensitivity:	10 - 400 MHz NFM = 12dB SINAD NFM 0.5 μ V AM = 10dB S/N AM 0.8 μ V WFM = 30dB S/N WFM 6.0 μ V 400 - 1000 MHz NFM 0.7 μ V WFM 6.0 μ V 1000 1500 MHz NFM 1.5 μ V
Selectable tuning steps:	AM & NFM 5kHz, 6.25kHz, 9kHz, 10kHz, 12.5kHz, 20kHz, 25kHz, 30kHz, 50kHz & 100kHz WFM 50kHz & 100kHz
Memory capacity:	500 ch total, 10 banks x 50 ch
Search banks:	10
Pass channels:	50 ch
VFO:	One
Priority channel:	One
Scan & search rate:	30ch/sec approx
Aerial input:	50 OHM BNC
Audio output:	110mW (6V 10%THD 8 OHM)
Power requirements:	4.8V from 4 x AA internal NiCads 6.0V manganese / alkaline 9.0 - 16V external
Current consumption:	95mA squelched - stand by 140mW (receive 50mW audio)

Notes